

# Acer Projector

A1200/B110/CE-X10/C11X/AX331

A1300W/B120/CE-W10/C11W/AW331

H5382BD/E232/HE-722

A1500/B150/CE-810/H6511BD

H6512BD/E146D/HE-805J/L552/V62/

H6510BD+/P1502 Series

User's Guide

Copyright © 2016. Acer Incorporated.  
All Rights Reserved.

Acer Projector User's Guide  
Original Issue: 05/2016

Changes may be made periodically to the information in this publication without obligation to notify any person of such revisions or changes. Such changes will be incorporated in new editions of this manual or supplementary documents and publications. This company makes no representations or warranties, either expressed or implied, with respect to the contents hereof and specifically disclaims the implied warranties of merchantability or fitness for a particular purpose.

Record the model number, serial number, purchase date and place of purchase information in the space provided below. The serial number and model number are recorded on the label affixed to your projector. All correspondence concerning your unit should include the serial number, model number and purchase information.

No part of this publication may be reproduced, stored in a retrieval system, or transmitted, in any form or by any means, electronically, mechanically, by photocopy, recording or otherwise, without the prior written permission of Acer Incorporated.

Model number: \_\_\_\_\_

Serial number: \_\_\_\_\_

Date of purchase: \_\_\_\_\_

Place of purchase: \_\_\_\_\_

Acer and the Acer logo are registered trademarks of Acer Incorporated. Other companies' product names or trademarks are used herein for identification purposes only and belong to their respective companies.

"HDMI™, the HDMI logo and High-Definition Multimedia Interface are trademarks or registered trademarks of HDMI Licensing LLC."



# Information for your safety and comfort

Read these instructions carefully. Keep this document for future reference. Follow all warnings and instructions marked on the product.

## Turning the product off before cleaning

Unplug this product from the wall outlet before cleaning. Do not use liquid cleaners or aerosol cleaners. Use a damp cloth for cleaning.

## Caution for plug as disconnecting device

Observe the following guidelines when connecting and disconnecting power to the external power supply unit:

- Install the power supply unit before connecting the power cord to the AC power outlet.
- Unplug the power cord before removing the power supply unit from the projector.
- If the system has multiple sources of power, disconnect power from the system by unplugging all power cords from the power supplies.

## Caution for Accessibility

Be sure that the power outlet you plug the power cord into is easily accessible and located as close to the equipment operator as possible. When you need to disconnect power to the equipment, be sure to unplug the power cord from the electrical outlet.



### Warnings!

- Do not use this product near water.
- Do not place this product on an unstable cart, stand or table. If the product falls, it could be seriously damaged.
- Slots and openings are provided for ventilation to ensure reliable operation of the product and to protect it from overheating. These openings must not be blocked or covered. The openings should never be blocked by placing the product on a bed, sofa, rug or other similar surface.

This product should never be placed near or over a radiator or heat register, or in a built-in installation unless proper ventilation is provided.

- Never push objects of any kind into this product through cabinet slots as they may touch dangerous voltage points or short-out parts that could result in a fire or electric shock. Never spill liquid of any kind onto or into the product.

- To avoid damage of internal components and to prevent battery leakage, do not place the product on a vibrating surface.
- Never use it under sporting, exercising, or any vibrating environment which will probably cause unexpected short current or damage rotor devices, lamp.

## Using electrical power

- This product should be operated from the type of power indicated on the marking label. If you are not sure of the type of power available, consult your dealer or local power company.
- Do not allow anything to rest on the power cord. Do not locate this product where people will walk on the cord.
- If an extension cord is used with this product, make sure that the total ampere rating of the equipment plugged into the extension cord does not exceed the extension cord ampere rating. Also, make sure that the total rating of all products plugged into the wall outlet does not exceed the fuse rating.
- Do not overload a power outlet, strip or receptacle by plugging in too many devices. The overall system load must not exceed 80% of the branch circuit rating. If power strips are used, the load should not exceed 80% of the power strip's input rating.
- This product's AC adapter is equipped with a three-wire grounded plug. The plug only fits in a grounded power outlet. Make sure the power outlet is properly grounded before inserting the AC adapter plug. Do not insert the plug into a non-grounded power outlet. Contact your electrician for details.

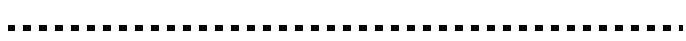

**Warning!** The grounding pin is a safety feature. Using a power outlet that is not properly grounded may result in electric shock and/or injury.



**Note:** The grounding pin also provides good protection from unexpected noise produced by other nearby electrical devices that may interfere with the performance of this product.

- Use the product only with the supplied power supply cord set. If you need to replace the power cord set, make sure that the new power cord meets the following requirements: detachable type, UL listed/CSA certified, VDE approved or its equivalent, 4.5 meters (15 feet) maximum length.

## Product servicing

Do not attempt to service this product yourself, as opening or removing covers may expose you to dangerous voltage points or other risks. Refer all servicing to qualified service personnel.

Unplug this product from the wall outlet and refer servicing to qualified service personnel when:

- the power cord or plug is damaged, cut or frayed
- liquid was spilled into the product
- the product was exposed to rain or water
- the product has been dropped or the case has been damaged
- the product exhibits a distinct change in performance, indicating a need for service
- the product does not operate normally after following the operating instructions



.....

**Note: Adjust only those controls that are covered by the operating instructions, since improper adjustment of other controls may result in damage and will often require extensive work by a qualified technician to restore the product to normal condition.**



.....

**Warning! For safety reasons, do not use non-compliant parts when adding or changing components. Consult your reseller for purchase options.**

Your device and its enhancements may contain small parts. Keep them out of the reach of small children.

## Additional safety information

- Do not look into the projector's lens when the lamp is on. The bright may hurt your eyes.
- Turn on the projector first and then signal sources
- Do not place the product in following environments:
  - Space that is poorly ventilated or confined. At least 50cm clearance from walls and free flow of air around the projector is necessary.
  - Locations where temperatures may become excessively high, such as inside of a car with all windows rolled up.
  - Locations where excessive humidity, dust, or cigarette smoke may contaminate optical components, shortening the life span and darkening the image.
  - Locations near fire alarms.
  - Locations with an ambient temperature above 40 °C/104 °F.
  - Locations where the altitudes are higher than 10000 feet.
- Unplug immediately if there is something wrong with your projector. Do not operate if smoke, strange noise or odor comes out of your projector. It might cause fire or electric shock. In this case, unplug immediately and contact your dealer.
- Do not keep using this product to break or drop it. In this case contact your dealer for inspection.
- Do not face the projector lens to the sun. It can lead to fire.
- When switching the projector off, suggest to ensure the projector completes its cooling cycle before disconnecting power.
- Do not frequently turn off the main power abruptly or unplug the projector during operation. The best way is to wait for the fan to turn off before turning main power off.

- Do not touch air outlet grille and bottom plate which becomes hot.
- Clean the air filter frequently if have. The temperature inside may rise and cause damage when the filter/ventilation slots clogged with dirt or dust.
- Do not look into the air outlet grille when projector is operating. It may hurt your eyes.
- Always open the lens shutter or remove the lens cap when the projector is on.
- Do not block the projector lens with any object when the projector is under operation as this could cause the object to become heated and deformed or even cause a fire. To temporarily turn off the lamp, press **HIDE** on the remote control.
- The lamp becomes extremely hot during operation. Allow the projector to cool for approximately 45 minutes prior to removing the lamp assembly for replacement.
- Do not operate lamps beyond the rated lamp life. It could cause it to break on rare occasions.
- Never replace the lamp assembly or any electronic components unless the projector is unplugged.
- The product will detect the life of the lamp itself. Please be sure to change the lamp when is showing warning message.
- When changing the lamp, please allow unit to cool down, and follow all changing instructions.
- Reset the "Lamp Hour Reset" function from the Onscreen display "Management" menu after replacing the lamp module.
- Do not attempt to disassemble this projector. There are dangerous high voltages inside which may hurt you. The only user serviceable part is the lamp which has its own removable cover. Refer servicing only to suitable qualified professional service personnel.
- Do not stand the projector on end vertically. It may cause the projector to fall over, causing injury or damage.
- This product is capable of displaying inverted images for ceiling mount installation. Only use acer ceiling mount kit for mounting the projector and ensure it is securely installed.
- The projector should be placed in a horizontal way by means of desktop or ceiling mount mode only, and its tilt angles should not exceed 6 degrees, otherwise it would cause dramatical decrease of lamp life or severe safety concern of system malfunction.



## Caution for Listening

To protect your hearing, follow these instructions.

- Increase the volume gradually until you can hear clearly and comfortably.
- Do not increase the volume level after your ears have adjusted.
- Do not listen to music at high volumes for extended periods.
- Do not increase the volume to block out noisy surroundings.
- Decrease the volume if you can't hear people speaking near you.

## Disposal instructions

Do not throw this electronic device into the trash when discarding. To minimize pollution and ensure utmost protection of the global environment, please recycle. For more information on the Waste from Electrical and Electronics Equipment (WEEE) regulations, visit

<http://www.acer-group.com/public/Sustainability/sustainability01.htm>



## Mercury advisory

For projectors or electronic products containing an LCD/CRT monitor or display:

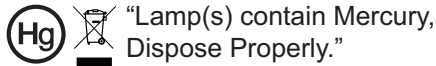

Lamp(s) inside this product contain mercury and must be recycled or disposed of according to local, state or federal laws. For more information, contact the Electronic Industries Alliance at [www.eiae.org](http://www.eiae.org). For lamp-specific disposal information, check [www.lamprecycle.org](http://www.lamprecycle.org)



## Do not stare into the beam, RG2

"As with any bright source, do not stare into the direct beam, RG2 IEC 62471-5:2015"

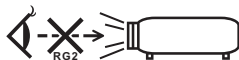

# First things first

## Usage Notes

Do:

- Turn off the product before cleaning.
- Use a soft cloth moistened with mild detergent to clean the display housing.
- Disconnect the power plug from AC outlet if the product is not being used for a long period of time.

Don't:

- Block the slots and openings on the unit provided for ventilation.
- Use abrasive cleaners, waxes or solvents to clean the unit.
- Use under the following conditions:
  - In extremely hot, cold or humid environments.
  - In areas susceptible to excessive dust and dirt.
  - Near any appliance that generates a strong magnetic field.
  - Place In direct sunlight.

## Precautions

Follow all warnings, precautions and maintenance as recommended in this user's guide to maximize the life of your unit.



### Warning:

- Do not look into the projector's lens when the lamp is on. The bright light may hurt your eyes.
- To reduce the risk of fire or electric shock, do not expose this product to rain or moisture.
- Please do not open or disassemble the product as this may cause electric shock.
- When changing the lamp, please allow unit to cool down, and follow all changing instructions.
- This product will detect the life of the lamp itself. Please be sure to change the lamp when it shows warning messages.
- Reset the "Lamp Hour Reset" function from the Onscreen display "Management" menu after replacing the lamp module.
- When switching the projector off, please ensure the projector completes its cooling cycle before disconnecting power.
- Turn on the projector first and then the signal sources.
- Do not use lens cap when projector is in operation.
- When the lamp reaches the end of its life, it will burn out and may make a loud popping sound. If this happens, the projector will not turn back on until the lamp module has been replaced. To replace the lamp, follow the procedures listed under "Replacing the Lamp".



|  |      |
|--|------|
| Information for your safety and comfort                          | iii  |
| First things first   | viii |
| Usage Notes  | viii |
| Precautions  | viii |
| Introduction   | 1    |
| Product Features   | 1    |
| Package Overview   | 2    |
| Projector Overview   | 3    |
| Projector Outlook  | 3    |
| Control Panel  | 6    |
| Remote Control Layout  | 7    |
| MHL (Mobile High-Definition Link) Control                        | 9    |
| Getting Started  | 11   |
| Connecting the Projector   | 11   |
| Turning the Projector On/Off                                     | 13   |
| Turning on the Projector   | 13   |
| Turning the projector off  | 14   |
| Adjusting the Projected Image                                    | 15   |
| Adjusting the Height of Projected Image                          | 15   |
| How to optimize image size and distance                          | 16   |
| How to get a preferred image size by adjusting distance and zoom | 20   |
| User Controls  | 24   |
| Installation menu  | 24   |
| Onscreen Display (OSD) Menus                                     | 25   |
| Color  | 26   |
| Image  | 28   |
| Setting  | 30   |
| Management   | 32   |
| Audio  | 33   |
| 3D   | 33   |
| Language   | 34   |
| Appendices   | 35   |

# Contents

|  |           |
|--|-----------|
| Troubleshooting                                  | 35        |
| LED & Alarm Definition Listing                   | 39        |
| How to install the Inner Dongle                  | 40        |
| Cleaning and replacing the dust filters (Option) | 41        |
| Replacing the Lamp                               | 42        |
| Ceiling Mount Installation                       | 43        |
| Specifications                                   | 46        |
| Compatibility modes                              | 49        |
| <b>Regulations and safety notices</b>            | <b>54</b> |

# Introduction

## Product Features

This product is a single-chip DLP® projector. Outstanding features include:

- DLP® technology
- A1200/B110/CE-X10/C11X/AX331 series: 1024x768 XGA resolution  
A1300W/B120/CE-W10/C11W/AW331 series: 1280x800 WXGA resolution  
H5382BD/E232/HE-722 series: 1280x720 720p resolution  
A1500/B150/CE-810/H6511BD/H6512BD/E146D/HE-805J/L552/V62/  
H6510BD+/P1502 series: 1920x1080 1080p resolution  
Full/4:3/16:9/16:10/L.Box aspect ratio supported
- Enables projecting 3D content via DLP Link Technology: Blue-Ray 3D supported and nVidia 3DTV Play Ready
- Acer ColorBoost technology delivers nature's true colors for vivid, life-like images
- High brightness and contrast ratio
- Acer LumiSense+ technology can intelligently optimize the brightness and color saturation of projected image based on actual ambient light.
- Versatile display modes (Bright, Presentation, Standard, sRGB, Rec. 709, Movie, Dark Cinema, Game, Sports, ISF Night, ISF Day, User) enable optimum performance in any situation
- NTSC / PAL / SECAM compatible and HDTV (480i/p, 576i/p, 720p, 1080i/p) supported
- Lower power consumption and economy (ECO) mode extend lamp life
- Acer EcoProjecton Technology delivers Intelligent power management approach and physical efficiency improvement
- Equipped with HDMI™ & MHL connection supporting HDCP
- Support HDMI CEC function
- Smart detection delivers quick, intelligent source detection
- Multi-language onscreen display (OSD) menus
- Manual focus projection lens zooms up to 1.1x or 1.3x
- 2x digital zoom
- Microsoft® Windows® 2000, XP, Vista®, Windows 7, Windows 8.1, Windows 10, Macintosh® OS compliant
- Support MHL V2.1 signal display
- Support LumiSense+
- Built-in One 3 Watts or 10 Watts speaker



.....  
**Note:** Functions vary depending on model definition.

# Package Overview

This projector comes with all the items shown below. Check to make sure your unit is complete. Contact your dealer immediately if any thing is missing.



Projector



Power cord



VGA cable



Security card  
(option)



User's guide



Quick start guide



Carrying case  
(option)



Dust filters  
(option)

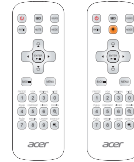

Remote control

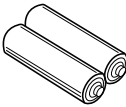

2 x Batteries  
(option)

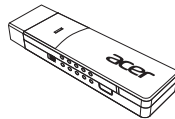

WirelessCAST  
(option)

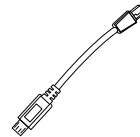

Micro USB to Mini USB  
80 mm cable (option)

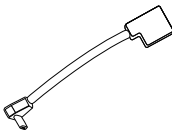

Micro USB (male) to Micro  
USB (female) 50 mm cable  
(option)

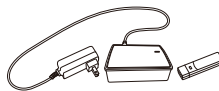

WirelessHD-Kit  
(option)

# Projector Overview

## Projector Outlook

Front / upper side

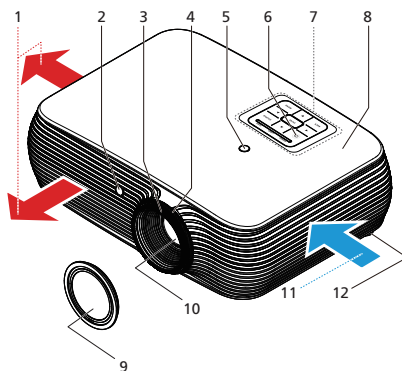

| # | Description             | #  | Description           |
|---|-------------------------|----|-----------------------|
| 1 | Air outlet              | 7  | Control panel         |
| 2 | Ambient light sensor    | 8  | Lamp cover            |
| 3 | Focus ring              | 9  | Lens cap              |
| 4 | Zoom ring               | 10 | Projection lens       |
| 5 | Remote control receiver | 11 | Air inlet             |
| 6 | Power button            | 12 | Tilt adjusting wheels |

Right / Rear side  
Type 1

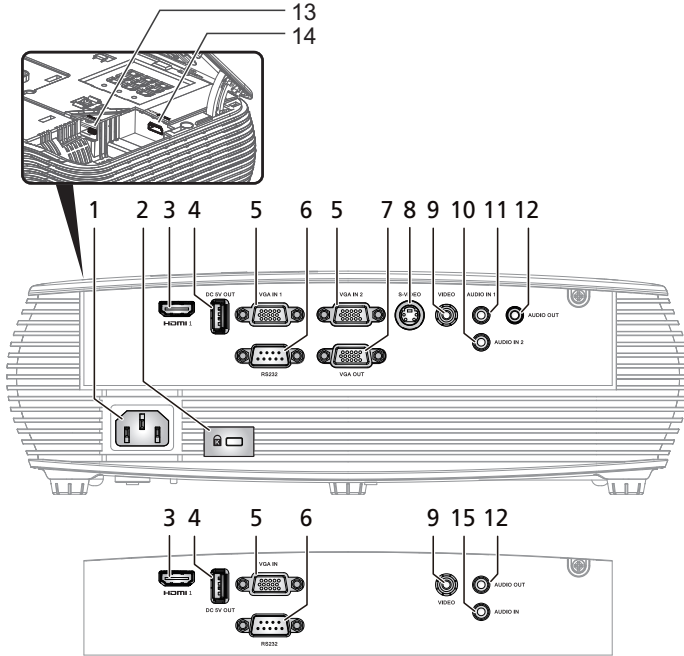

| # | Description  | #  | Description                                   |
|---|--|----|---|
| 1 | Power socket   | 9  | Composite video input connector               |
| 2 | Kensington™ lock port  | 10 | Audio in 2 connector (for S-Video, Composite) |
| 3 | HDMI 1 connector   | 11 | Audio in 1 connector (for VGA IN 1, VGA IN 2) |
| 4 | 5V DC output connector (device charge & support mouse page up/down function) | 12 | Audio out connector                           |
| 5 | PC analog signal/HDTV/component video input connector (VGA IN 1, VGA IN 2)   | 13 | Internal 5V connector                         |
| 6 | RS232 connector  | 14 | HDMI 2/MHL connector                          |
| 7 | Monitor loop-through output connector (for VGA IN 1 only)                    | 15 | Audio in connector                            |
| 8 | S-Video input connector  |    |   |



.....  
**Note:** Functions vary depending on model definition.

## Type 2

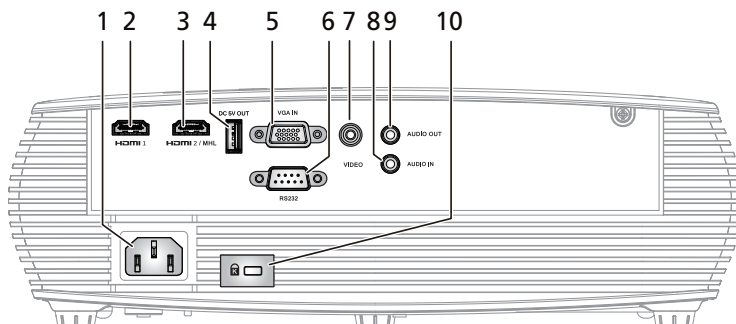

| # | Description  | #  | Description                     |
|---|--|----|---------------------------------|
| 1 | Power socket   | 6  | RS232 connector                 |
| 2 | HDMI 1 connector   | 7  | Composite video input connector |
| 3 | HDMI 2/MHL connector   | 8  | Audio in connector              |
| 4 | 5V DC output connector (device charge & support mouse page up/down function) | 9  | Audio out connector             |
| 5 | PC analog signal/HDTV/component video input connector                        | 10 | Kensington™ lock port           |



**Note:** Functions vary depending on model definition.

## Control Panel

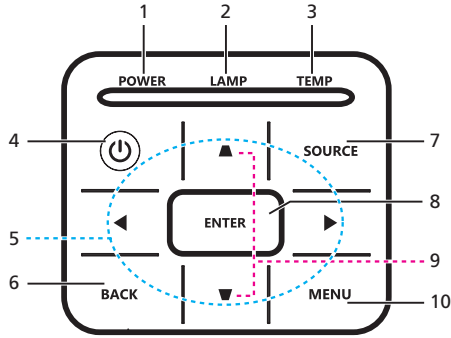

| #  | Icon   | Function                     | Description   |
|----|--------|------------------------------|---|
| 1  | POWER  | POWER                        | Power Indicator LED   |
| 2  | LAMP   | LAMP                         | Lamp Indicator LED  |
| 3  | TEMP   | TEMP                         | Temp Indicator LED  |
| 4  |        | POWER                        | See the contents in "Turning the Projector On/Off" section.   |
| 5  |        | Four directional select keys | Use ▲▼▶◀ to select items or make adjustments to your selection.   |
| 6  | BACK   | BACK                         | Returns to the previous operation.  |
| 7  | SOURCE | SOURCE                       | Changes the active source.  |
| 8  | ENTER  | ENTER                        | Confirm your selection of items.  |
| 9  |        | Keystone                     | Adjusts the image to compensate for distortion caused by tilting the projector.   |
| 10 | MENU   | MENU                         | Press " <b>MENU</b> " to launch the Onscreen display (OSD) menu, back to the previous step for the OSD menu operation or exit the OSD menu. |









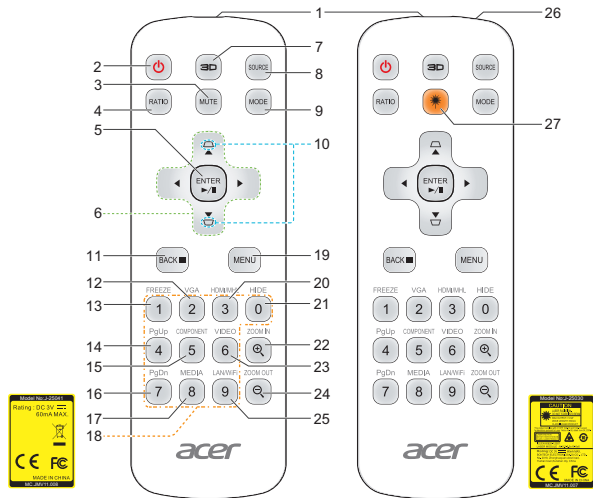







**Note:** Functions vary depending on model definition.



## Remote Control Layout



| #  | Icon | Function                     | Description  |
|----|------|------------------------------|--|
| 1  |      | Infrared transmitter         | Sends signals to the projector.  |
| 2  |      | POWER                        | Refer to the " <b>Turning the Projector On/Off</b> " section.  |
| 3  |      | MUTE                         | To turn on/off the volume.   |
| 4  |      | RATIO                        | To choose the desired aspect ratio.  |
| 5  |      | Select/Enter                 | Confirm your selection of items.   |
|    |      | Play/Pause                   | Press to begin/pause playback.   |
| 6  |      | Four directional select keys | Use up, down, left, right buttons to select items or make adjustments to your selection.   |
| 7  |      | 3D                           | Press "3D" to select 3D models.  |
| 8  |      | SOURCE                       | Changes the active source.   |
| 9  |      | MODE                         | Press " <b>MODE</b> " to select the display mode from Bright, Presentation, Standard, Video and User.  |
| 10 |      | KEYSTONE                     | Adjusts the image to compensate for distortion caused by tilting the projector.  |
| 11 |      | BACK                         | Returns to the previous operation.   |
|    |      | STOP                         | Press to stop playback.  |
| 12 |      | VGA                          | Press " <b>VGA</b> " to change source to the VGA connector. This connector supports analog RGB, YPbPr (480p/576p/720p/1080i), YCbCr (480i/576i) and RGBsync. |

| #  | Icon  | Function      | Description  |
|----|---|---------------|--|
| 13 |    | FREEZE        | To pause the screen image.   |
| 14 |    | PgUp          | For computer mode only. Use this button to select the previous page. This function is only available when USB Ctrl connector (mini type B) is connected to a computer via a USB cable.   |
| 15 |    | COMPONENT     | No function.   |
| 16 |    | PgDn          | For computer mode only. Use this button to select the next page. This function is only available when USB Ctrl connector (mini type B) is connected to a computer via a USB cable.   |
| 17 |    | MEDIA         | No function.   |
| 18 |    | KeyPad 0~9    | Press " <b>0~9</b> " to input a password in the "Security" OSD.  |
| 19 |    | MENU          | <ul style="list-style-type: none"> <li>Press "MENU" to launch the Onscreen display (OSD) menu, back to the previous step for the OSD menu operation or exit the OSD menu.</li> <li>Confirm your selection of items.</li> </ul> |
| 20 |    | HDMI™/MHL     | To change source to HDMI/MHL.  |
| 21 |    | HIDE          | Momentarily turns off the video. Press " <b>HIDE</b> " to hide the image, press again to display the image.  |
| 22 |    | ZOOM IN       | Zooms the projector display in.  |
| 23 |   | VIDEO         | To change source to COMPOSITE VIDEO.   |
| 24 |  | ZOOM OUT      | Zooms the projector display out.   |
| 25 |  | LAN/WiFi      | Press "LAN/WiFi" to change source to "WiFi." Only available while Acer WirelessCAST (MWA3) is plugged in projector and see "WiFi" in source list.  |
| 26 |   | Laser pointer | Aim the remote at the viewing screen.  |
| 27 |  | Laser button  | Aim the remote at the viewing screen, press and hold this button to activate the laser pointer.  |





.....

**Note:** Functions vary depending on model definition.

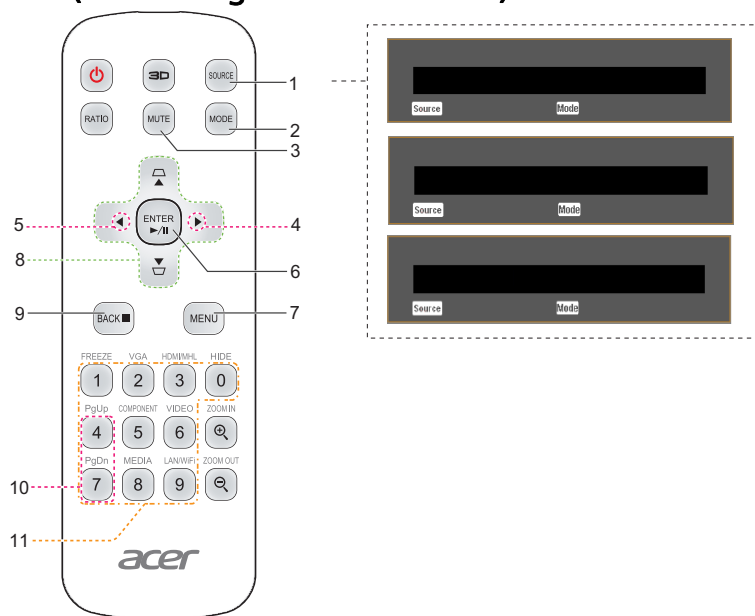
## MHL (Mobile High-Definition Link) Control



| # | Icon | Function                     | Description   |
|---|------|------------------------------|---|
| 1 |      | SOURCE                       | Press the "SOURCE" button to toggle between Navigation, Numeric and Multi-Media mode.   |
| 2 |      | MODE                         | <ul style="list-style-type: none"> <li>Press "MODE" button for one second to activate the MHL Control Mode.</li> <li>To exit, press the "MODE" button again.</li> </ul> |
| 3 |      | MUTE                         | To turn on/off the volume. (only for <b>Navigation</b> or <b>Multi-Media</b> mode)  |
| 4 |      | Volume UP                    | Increases the volume. (only for <b>Multi-Media</b> mode)  |
| 5 |      | Volume Down                  | Decreases the volume. (only for <b>Multi-Media</b> mode)  |
| 6 |      | Select/Enter                 | Press to select/enter the file. (only for <b>Navigation</b> mode)   |
|   |      | Play/Pause                   | Toggles between playback and pause. (only for <b>Multi-Media</b> mode)  |
| 7 |      | MENU                         | Press to launch the root menu. (only for <b>Navigation</b> mode)  |
| 8 |      | Four directional select keys | Use up, down, left, right buttons to select items or make adjustments to your selection. (only for <b>Navigation</b> mode)  |
| 9 |      | Back/Exit                    | <ul style="list-style-type: none"> <li>Press "BACK" to go back one menu step.</li> <li>To exit the file. (only for <b>Navigation</b> mode)</li> </ul>                   |
|   |      | Stop                         | Discontinues playback. (only for <b>Multi-Media</b> mode)   |

| #  | Icon   | Function   | Description   |
|----|--|------------|---|
| 10 | <br>PgUp<br><br>PgDn | PgUp/PgDn  | Use the button to select the next or previous page. (only for <b>Navigation</b> mode) |
| 11 |   | KeyPad 0~9 | Number buttons. (only for <b>Numeric</b> mode)  |



.....  
**Note:** Functions vary depending on model definition.

# Getting Started

## Connecting the Projector

### Type 1

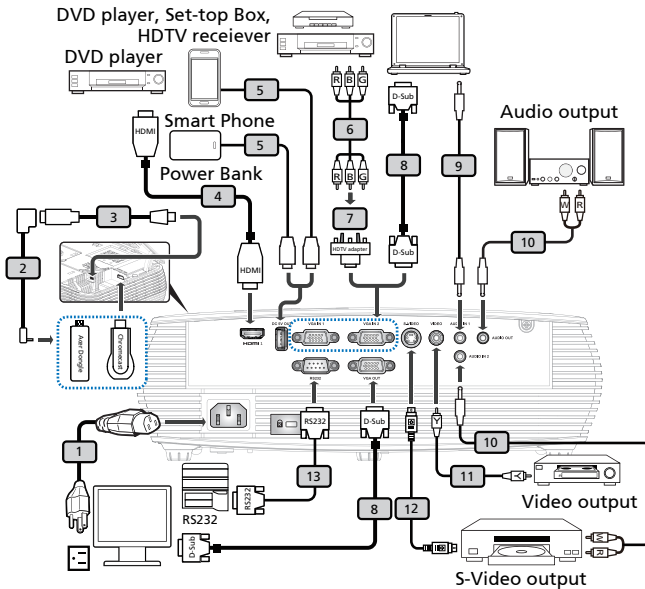

| # | Description  | #  | Description           |
|---|--|----|-----------------------|
| 1 | Power cord   | 8  | VGA cable             |
| 2 | Micro USB (male) to Micro USB (female) 50 mm cable | 9  | Audio cable Jack/Jack |
| 3 | Micro USB to Mini USB 80 mm cable                  | 10 | Audio cable Jack/RCA  |
| 4 | HDMI cable   | 11 | Composite video cable |
| 5 | USB cable for charging device                      | 12 | S-Video cable         |
| 6 | 3 RCA component cable                              | 13 | RS232 cable           |
| 7 | VGA to component/HDTV adapter                      |    |                       |



**Note 1:** To ensure the projector works well with your computer, please make sure the timing of the display mode is compatible with the projector.

**Note 2:** Functions vary depending on model definition.

**Note 3:** USB cable needs powered extender if the length is over 5 m.

**Note 4:** Some smartphones require a converter (supplied by smartphone maker) to enable the MHL function.

**Note 5:** USB DC 5V out connector support 5V/2.0A power output for power bank charging only when MHL source is not detected.

**Note 6:** VGA OUT loops through for VGA IN 1 only.

Type 2

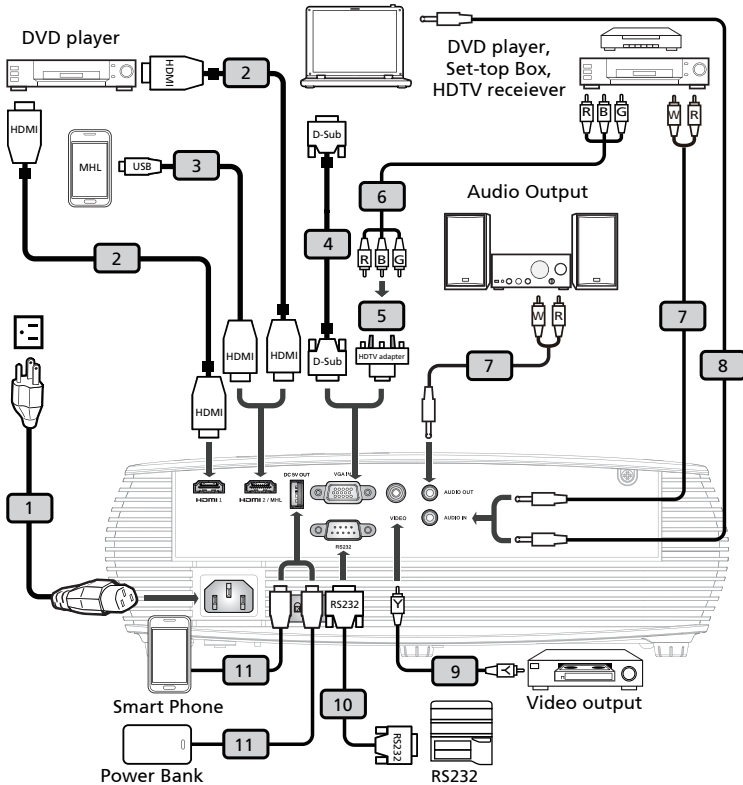

| # | Description                   | #  | Description                   |
|---|-------------------------------|----|-------------------------------|
| 1 | Power cord                    | 7  | Audio cable Jack/RCA          |
| 2 | HDMI cable                    | 8  | Audio cable Jack/Jack         |
| 3 | MHL cable (MicroUSB to HDMI)  | 9  | Composite video cable         |
| 4 | VGA cable                     | 10 | RS232 cable                   |
| 5 | VGA to component/HDTV adapter | 11 | USB cable for charging device |
| 6 | 3 RCA component cable         |    |                               |



**Note 1:** To ensure the projector works well with your computer, please make sure the timing of the display mode is compatible with the projector.

**Note 2:** Functions vary depending on model definition.

**Note 3:** USB cable needs powered extender if the length is over 5 m.

**Note 4:** Some smartphones require a converter (supplied by smartphone maker) to enable the MHL function.

**Note 5:** USB DC 5V out connector support 5V/1.0A power output for power bank charging only when MHL source is not detected.

# Turning the Projector On/Off

## Turning on the Projector

- 1 Ensure that the power cord and signal cable are securely connected. The Power indicator LED will flash red.
- 2 Turn on the projector by pressing "**Power**" button on the control panel or remote control, and the Power indicator LED will turn blue.
- 3 Turn on your source (computer, notebook, video player ,etc.). The projector will detect your source automatically.
  - If the screen displays "Lock" and "Source" icons, it means the projector is locked onto a specific source type and there is no such type of input signal detected.
  - If the screen displays "No Signal", please make sure the signal cables are securely connected or press source direct key.
  - If you connect to multiple sources at the same time, use the "Source" button on either control panel or the remote control or direct source key on the remote control to switch between inputs.



## Turning the projector off

- 1 To turn the projector off, press and hold the power button. This message appears: **"Please press the power button again to complete the shutdown process."** Press the power button again.
- 2 The LED power indicator will turn RED and blink rapidly after the projector is turned off, and the fan(s) will continue to operate for about 2 minutes to ensure that the system cools properly. (only supported under "Instant Resume" mode)
- 3 As long as the power cord remains plugged in, you can press the power button to turn the projector immediately back on anytime during the 2-minute shutdown process. (only supported under "Instant Resume" mode)
- 4 Once the system has finished cooling, the LED power indicator will stop blinking and turn solid red to indicate standby mode.
- 5 It is now safe to unplug the power cord.



### Warning indicators:

- **"Projector Overheated. Lamp will automatically turn off soon."**  
This onscreen message indicates that the projector has overheated. The lamp will automatically turn off, the projector will automatically shut down, and the LED temp indicator will turn solid red. Contact your local dealer or service center.
- **"Fan failed. Lamp will automatically turn off soon."**  
This onscreen message indicates that the fan has failed. The lamp will automatically turn off, the projector will automatically shut down, and the LED temp indicator will blink. Contact your local dealer or service center.



**Note 1:** Whenever the projector automatically shuts down and the LED lamp indicator turns solid red, contact your local reseller or service center.

**Note 2:** Functions vary depending on model definition.

**Attention!** The projector will enter a two minute cool down period to ensure continued optimal lamp operation.



## Adjusting the Projected Image

### Adjusting the Height of Projected Image

The projector is equipped with elevator feet for adjusting the height of image.

To raise/lower the image:

Use Tilt adjusting wheel to fine-tune the display angle.

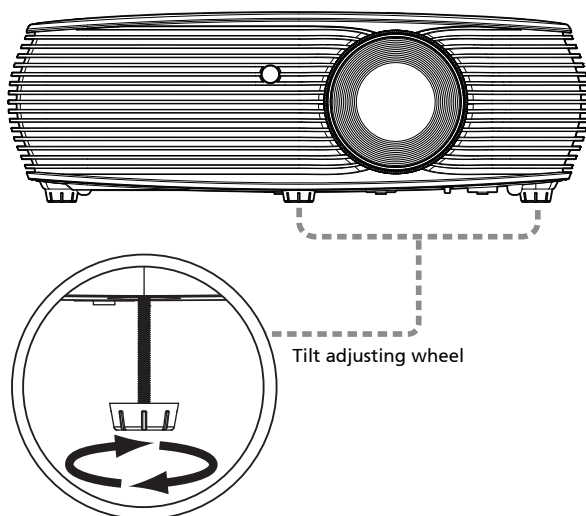

## How to optimize image size and distance

Consult the table below to find the optimal image sizes achievable when the projector is positioned at a desired distance from the screen.

- XGA series

If the projector is 2.0 m from the screen, good image quality is possible for image sizes between 51" and 66".



**Note:** Remind as below figure, the space of 116 cm height is required when located at 2 m distance.

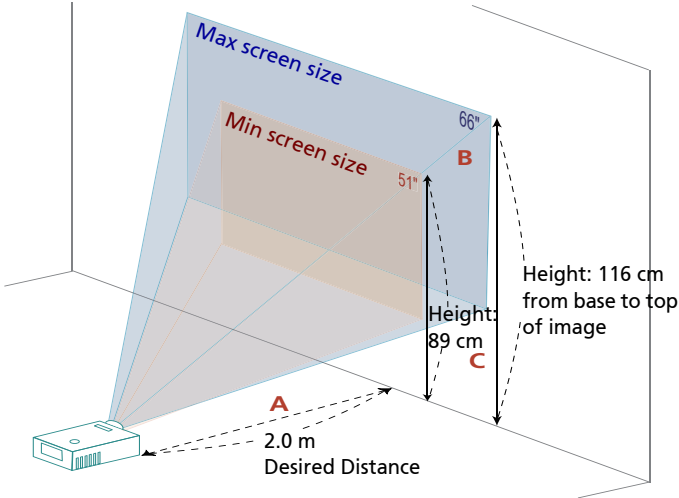

| Desired Distance (m) <A> | Screen size         |                 |                                    | Screen size         |                 |                                    |
|--------------------------|---------------------|-----------------|------------------------------------|---------------------|-----------------|------------------------------------|
|                          | Top                 |                 |                                    | Top                 |                 |                                    |
|                          | (Min zoom)          |                 |                                    | (Max zoom)          |                 |                                    |
|                          | Diagonal (inch) <B> | W (cm) x H (cm) | From base to top of image (cm) <C> | Diagonal (inch) <B> | W (cm) x H (cm) | From base to top of image (cm) <C> |
| 1.2                      | 30.58               | 62 x 47         | 54                                 | 40                  | 81 x 61         | 70                                 |
| 1.5                      | 38                  | 78 x 58         | 67                                 | 50                  | 101 x 76        | 87                                 |
| 2.0                      | 51                  | 104 x 78        | 89                                 | 66                  | 134 x 101       | 116                                |
| 3.0                      | 76                  | 155 x 117       | 134                                | 99                  | 202 x 151       | 174                                |
| 4.0                      | 102                 | 207 x 155       | 179                                | 132                 | 269 x 202       | 232                                |
| 5.0                      | 127                 | 259 x 194       | 223                                | 165                 | 336 x 252       | 290                                |
| 6.0                      | 153                 | 311 x 233       | 268                                | 199                 | 403 x 303       | 348                                |
| 7.0                      | 178                 | 363 x 272       | 313                                | 232                 | 471 x 353       | 406                                |
| 8.0                      | 204                 | 414 x 311       | 357                                | 265                 | 538 x 403       | 464                                |
| 9.1                      | 232                 | 471 x 353       | 406                                | 301.17              | 612 x 459       | 528                                |

Zoom Ratio: 1.30x

- WXGA series

If the projector is 2 m from the screen, good image quality is possible for image sizes between 60" and 78".



**Note:** Remind as below figure, the space of 118 cm height is required when located at 2 m distance.

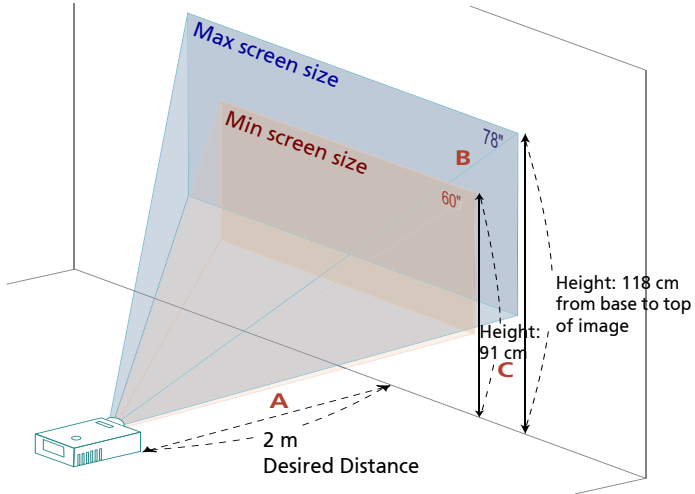

| Desired Distance (m) <A> | Screen size (Min zoom) |                 | Top                                | Screen size (Max zoom) |                 | Top                                |
|--------------------------|------------------------|-----------------|------------------------------------|------------------------|-----------------|------------------------------------|
|                          | Diagonal (inch) <B>    | W (cm) x H (cm) | From base to top of image (cm) <C> | Diagonal (inch) <B>    | W (cm) x H (cm) | From base to top of image (cm) <C> |
| 1.2                      | 36.08                  | 78 x 49         | 55                                 | 47                     | 101 x 63        | 71                                 |
| 1.5                      | 45                     | 97 x 61         | 68                                 | 59                     | 126 x 79        | 89                                 |
| 2.0                      | 60                     | 130 x 81        | 91                                 | 78                     | 168 x 105       | 118                                |
| 3.0                      | 90                     | 194 x 121       | 136                                | 117                    | 253 x 158       | 178                                |
| 4.0                      | 120                    | 259 x 162       | 182                                | 156                    | 337 x 211       | 237                                |
| 5.0                      | 150                    | 324 x 202       | 227                                | 196                    | 421 x 263       | 296                                |
| 6.0                      | 180                    | 389 x 243       | 273                                | 235                    | 505 x 316       | 355                                |
| 7.0                      | 210                    | 453 x 283       | 318                                | 274                    | 590 x 369       | 414                                |
| 7.7                      | 232                    | 499 x 312       | 350                                | 301.17                 | 649 x 405       | 456                                |

Zoom Ratio: 1.30x

- 720p series

If the projector is 2 m from the screen, good image quality is possible for image sizes between 53" and 59".



**Note:** Remind as below figure, the space of 87 cm height is required when located at 2 m distance.

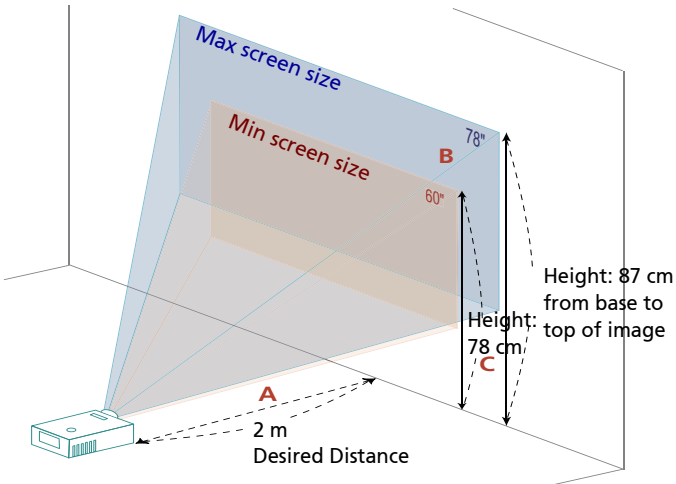

| Desired Distance (m) <A> | Screen size         |                 | Top                                | Screen size         |                 | Top                                |
|--------------------------|---------------------|-----------------|------------------------------------|---------------------|-----------------|------------------------------------|
|                          | (Min zoom)          |                 |                                    | (Max zoom)          |                 |                                    |
|                          | Diagonal (inch) <B> | W (cm) x H (cm) | From base to top of image (cm) <C> | Diagonal (inch) <B> | W (cm) x H (cm) | From base to top of image (cm) <C> |
| 1                        | 26.26               | 58 x 33         | 39                                 | 29                  | 65 x 36         | 43                                 |
| 1.5                      | 39                  | 87 x 49         | 59                                 | 44                  | 97 x 55         | 65                                 |
| 2.0                      | 53                  | 116 x 65        | 78                                 | 59                  | 130 x 73        | 87                                 |
| 3.0                      | 79                  | 174 x 98        | 117                                | 88                  | 194 x 109       | 130                                |
| 4.0                      | 105                 | 233 x 131       | 156                                | 117                 | 259 x 146       | 174                                |
| 5.0                      | 131                 | 291 x 164       | 195                                | 146                 | 324 x 182       | 217                                |
| 6.0                      | 158                 | 349 x 196       | 234                                | 176                 | 389 x 219       | 261                                |
| 7.0                      | 184                 | 407 x 229       | 273                                | 205                 | 453 x 255       | 304                                |
| 8.0                      | 210                 | 465 x 262       | 312                                | 234                 | 518 x 291       | 348                                |
| 9.0                      | 236                 | 523 x 294       | 351                                | 263                 | 583 x 328       | 391                                |
| 10.3                     | 271                 | 599 x 337       | 402                                | 301.34              | 667 x 375       | 448                                |

Zoom Ratio: 1.11x

- 1080p series

If the projector is 2 m from the screen, good image quality is possible for image sizes between 61" and 80".



**Note:** Remind as below figure, the space of 115 cm height is required when located at 2 m distance.

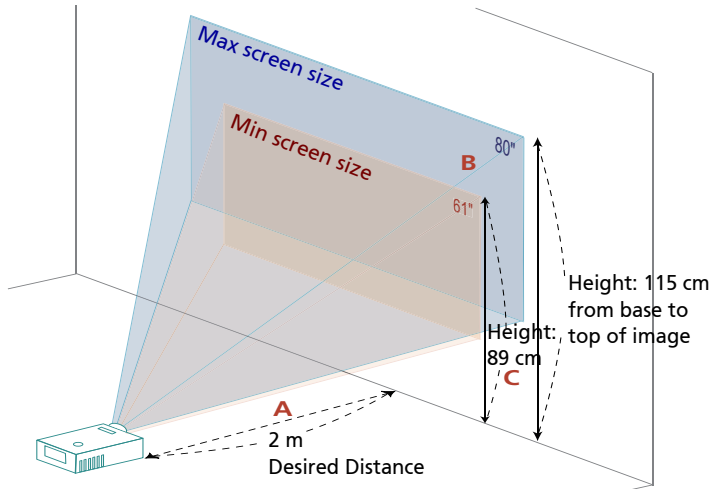

| Desired Distance (m) <A> | Screen size         |                 | Top                                | Screen size         |                 | Top                                |
|--------------------------|---------------------|-----------------|------------------------------------|---------------------|-----------------|------------------------------------|
|                          | (Min zoom)          |                 |                                    | (Max zoom)          |                 |                                    |
|                          | Diagonal (inch) <B> | W (cm) x H (cm) | From base to top of image (cm) <C> | Diagonal (inch) <B> | W (cm) x H (cm) | From base to top of image (cm) <C> |
| 1.2                      | 36.85               | 82 x 46         | 53                                 | 48                  | 106 x 60        | 69                                 |
| 1.5                      | 46                  | 102 x 57        | 67                                 | 60                  | 133 x 75        | 87                                 |
| 2.0                      | 61                  | 136 x 76        | 89                                 | 80                  | 177 x 100       | 115                                |
| 2.5                      | 77                  | 170 x 96        | 111                                | 100                 | 221 x 124       | 144                                |
| 3.0                      | 92                  | 204 x 115       | 133                                | 120                 | 265 x 149       | 173                                |
| 3.5                      | 107                 | 238 x 134       | 155                                | 140                 | 310 x 174       | 202                                |
| 4.0                      | 123                 | 272 x 153       | 177                                | 160                 | 354 x 199       | 231                                |
| 5.0                      | 154                 | 340 x 191       | 222                                | 200                 | 422 x 249       | 289                                |
| 6.0                      | 184                 | 408 x 229       | 266                                | 240                 | 531 x 299       | 346                                |
| 7.0                      | 215                 | 476 x 268       | 311                                | 280                 | 619 x 348       | 404                                |
| 7.5                      | 230                 | 510 x 287       | 333                                | 299.81              | 664 x 373       | 433                                |

Zoom Ratio: 1.30x

## How to get a preferred image size by adjusting distance and zoom

The table below shows how to achieve a desired image size by adjusting either the position or the zoom ring.

- XGA series

To obtain an image size of 60" set the projector at a distance 1.8 m and 2.4 m from the screen.

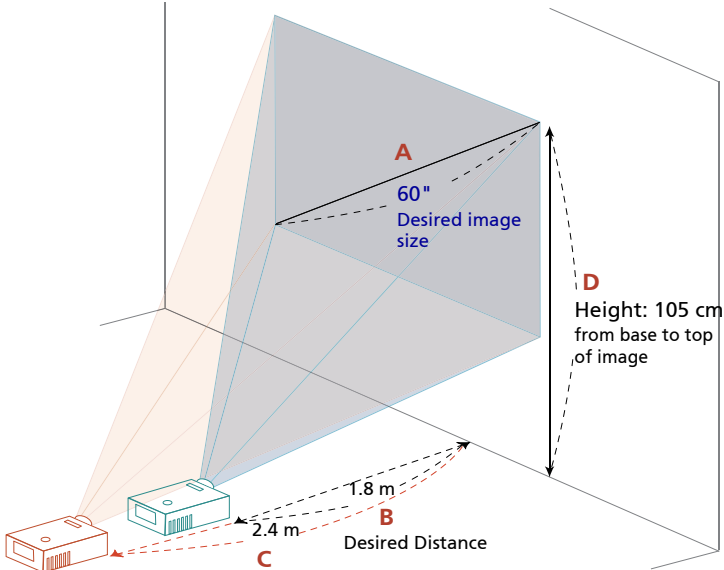

| Desired Image Size     |                 | Distance (m)    |                 | Top (cm)                            |
|------------------------|-----------------|-----------------|-----------------|-------------------------------------|
| Diagonal (inch)<br><A> | W (cm) x H (cm) | Max zoom<br><B> | Min zoom<br><C> | From base to top of<br>image<br><D> |
| 30                     | 61 x 46         |                 | 1.2             | 53                                  |
| 40                     | 81 x 61         | 1.2             | 1.6             | 70                                  |
| 50                     | 102 x 76        | 1.5             | 2.0             | 88                                  |
| 60                     | 122 x 91        | 1.8             | 2.4             | 105                                 |
| 70                     | 142 x 107       | 2.1             | 2.7             | 123                                 |
| 80                     | 163 x 122       | 2.4             | 3.1             | 140                                 |
| 90                     | 183 x 137       | 2.7             | 3.5             | 158                                 |
| 100                    | 203 x 152       | 3.0             | 3.9             | 175                                 |
| 150                    | 305 x 229       | 4.5             | 5.9             | 263                                 |
| 180                    | 366 x 274       | 5.4             | 7.1             | 315                                 |
| 200                    | 406 x 305       | 6.0             | 7.8             | 351                                 |
| 250                    | 508 x 381       | 7.6             | 9.8             | 438                                 |
| 300                    | 610 x 457       | 9.1             |                 | 526                                 |

Zoom Ratio: 1.30x

- WXGA series

To obtain an image size of 60" set the projector at a distance 1.5 m and 2.0 m from the screen.

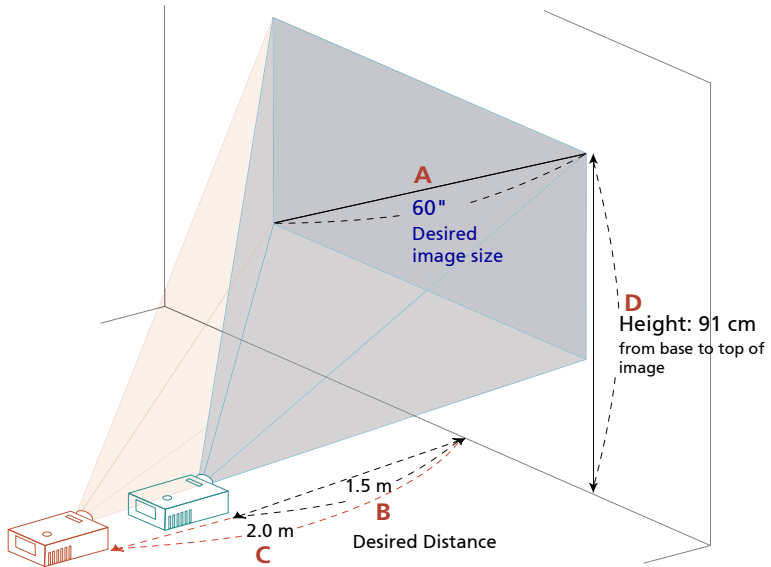

| Desired Image Size     |                 | Distance (m)    |                 | Top (cm)                            |
|------------------------|-----------------|-----------------|-----------------|-------------------------------------|
| Diagonal (inch)<br><A> | W (cm) x H (cm) | Max zoom<br><B> | Min zoom<br><C> | From base to top of<br>image<br><D> |
| 30                     | 65 x 40         |                 | 1.0             | 45                                  |
| 40                     | 86 x 54         | 1.0             | 1.3             | 61                                  |
| 50                     | 108 x 67        | 1.3             | 1.7             | 76                                  |
| 60                     | 129 x 81        | 1.5             | 2.0             | 91                                  |
| 70                     | 151 x 94        | 1.8             | 2.3             | 106                                 |
| 80                     | 172 x 108       | 2.0             | 2.7             | 121                                 |
| 90                     | 194 x 121       | 2.3             | 3.0             | 136                                 |
| 100                    | 215 x 135       | 2.6             | 3.3             | 151                                 |
| 150                    | 323 x 202       | 3.8             | 5.0             | 227                                 |
| 180                    | 388 x 242       | 4.6             | 6.0             | 272                                 |
| 200                    | 431 x 269       | 5.1             | 6.7             | 303                                 |
| 250                    | 538 x 337       | 6.4             | 8.3             | 378                                 |
| 300                    | 646 x 404       | 7.7             |                 | 454                                 |

Zoom Ratio: 1.30x

- 720p series

To obtain an image size of 60" set the projector at a distance 2.1 m and 2.3 m from the screen.

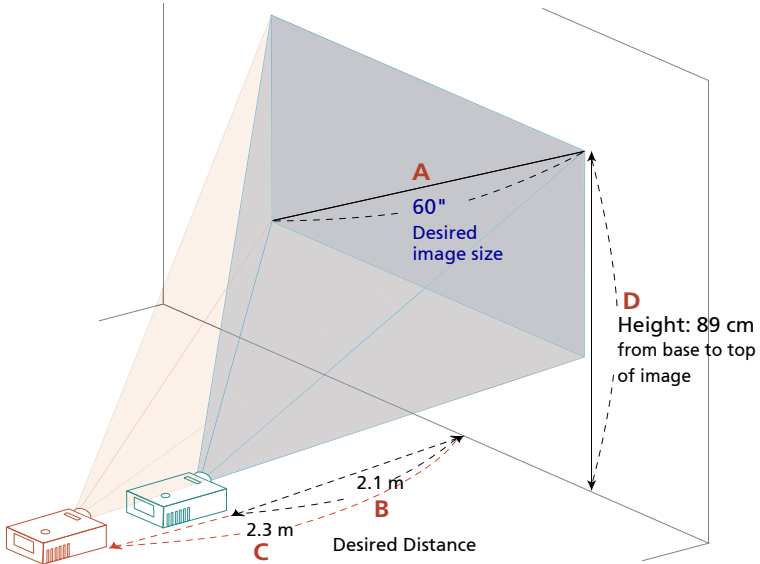

| Desired Image Size     |                 | Distance (m)    |                 | Top (cm)                            |
|------------------------|-----------------|-----------------|-----------------|-------------------------------------|
| Diagonal (inch)<br><A> | W (cm) x H (cm) | Max zoom<br><B> | Min zoom<br><C> | From base to top of<br>image<br><D> |
| 29                     | 64 x 36         | 1.0             | 1.1             | 43                                  |
| 40                     | 89 x 50         | 1.4             | 1.5             | 59                                  |
| 50                     | 111 x 62        | 1.7             | 1.9             | 74                                  |
| 60                     | 133 x 75        | 2.1             | 2.3             | 89                                  |
| 70                     | 155 x 87        | 2.4             | 2.7             | 104                                 |
| 80                     | 177 x 100       | 2.7             | 3.0             | 119                                 |
| 90                     | 199 x 112       | 3.1             | 3.4             | 134                                 |
| 100                    | 221 x 125       | 3.4             | 3.8             | 149                                 |
| 150                    | 332 x 187       | 5.1             | 5.7             | 223                                 |
| 180                    | 398 x 224       | 6.2             | 6.9             | 267                                 |
| 200                    | 443 x 249       | 6.8             | 7.6             | 297                                 |
| 250                    | 553 x 311       | 8.5             | 9.5             | 371                                 |
| 300                    | 664 x 374       | 10.3            |                 | 446                                 |

Zoom Ratio: 1.11x



- 1080p series

To obtain an image size of 60" set the projector at a distance 1.5 m and 2.0 m from the screen.

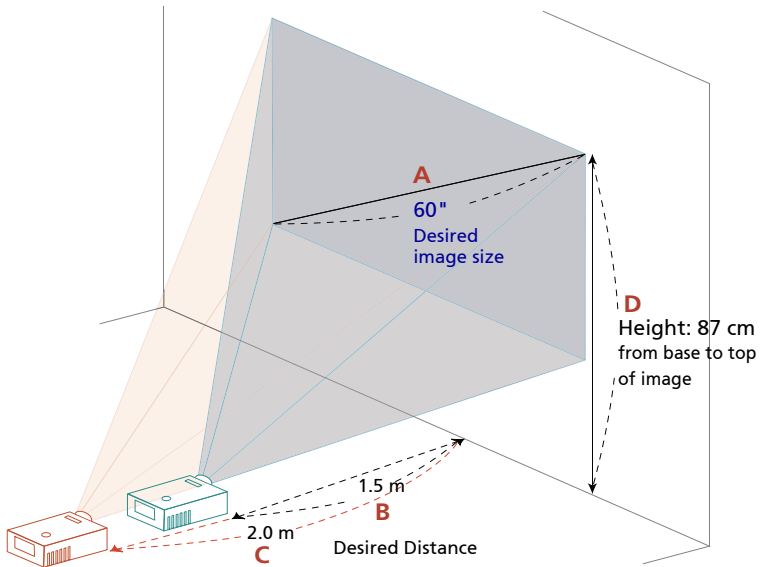

| Desired Image Size     |                 | Distance (m)    |                 | Top (cm)                         |
|------------------------|-----------------|-----------------|-----------------|----------------------------------|
| Diagonal (inch)<br><A> | W (cm) x H (cm) | Max zoom<br><B> | Min zoom<br><C> | From base to top of image<br><D> |
| 30                     | 66 x 37         |                 | 1.0             | 43                               |
| 40                     | 89 x 50         | 1.0             | 1.3             | 58                               |
| 50                     | 111 x 62        | 1.3             | 1.6             | 72                               |
| 60                     | 133 x 75        | 1.5             | 2.0             | 87                               |
| 70                     | 155 x 87        | 1.8             | 2.3             | 101                              |
| 80                     | 177 x 100       | 2.0             | 2.6             | 116                              |
| 90                     | 199 x 112       | 2.3             | 2.9             | 130                              |
| 100                    | 221 x 125       | 2.5             | 3.3             | 144                              |
| 150                    | 332 x 187       | 3.8             | 4.9             | 217                              |
| 180                    | 398 x 224       | 4.5             | 5.9             | 260                              |
| 200                    | 443 x 249       | 5.0             | 6.5             | 289                              |
| 250                    | 553 x 311       | 6.3             | 8.1             | 361                              |
| 300                    | 664 x 374       | 7.5             |                 | 433                              |

Zoom Ratio: 1.30x

# User Controls

## Installation menu

The installation menu provides an onscreen display (OSD) for projector installation and maintenance. Use the OSD only when the message "No signal input" is displayed on the screen.

The menu options include settings and adjustments for screen size and distance, focus, keystone correction and more .

- 1 Turn on the projector by pressing "**Power**" button on the control pad.
- 2 Press the "**MENU**" button on the remote control to launch the OSD for projector installation and maintenance.

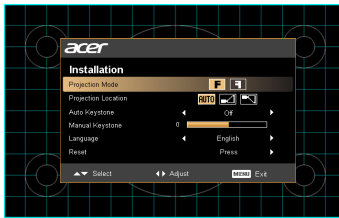

- 3 The background pattern acts as a guide to adjusting the calibration and alignment settings, such as screen size and distance, focus and more .
- 4 The Installation menu includes the following options:
  - Projection Mode
  - Projection Location
  - Auto Keystone settings
  - Manual Keystone settings
  - WirelessHD Dongle Pairing
  - Language settings
  - Reset to factory default function

Use the up and down arrow keys to select an option, the left and right arrow keys to adjust selected option settings, and the "ENTER" to enter a submenu for feature setting. The new settings will be saved automatically upon exiting the menu.

- 5 Push the "MENU" or "BACK" button anytime to exit the menu and return to the Acer welcome screen.









**Note:** Functions vary depending on model definition.

## Onscreen Display (OSD) Menus

The projector has multilingual OSD that allow you to make image adjustments and change a variety of settings.

### Using the OSD menu

- To open the OSD menu, press **"MENU"** on the remote control or control panel.
- When the OSD is displayed, use the   keys to select any item in the main menu. After selecting the desired main menu item, press **"ENTER"** to enter submenu for feature setting.
- Use the   keys to select the desired item and adjust the settings by using the   keys.
- Select the next item to be adjusted in the submenu and adjust as described above.
- Press **"BACK"** on the remote control or control panel, the screen will return to the main menu.
- To exit OSD, press **"BACK"** on the remote control or control panel. The OSD menu will close and the projector will automatically save the new settings.

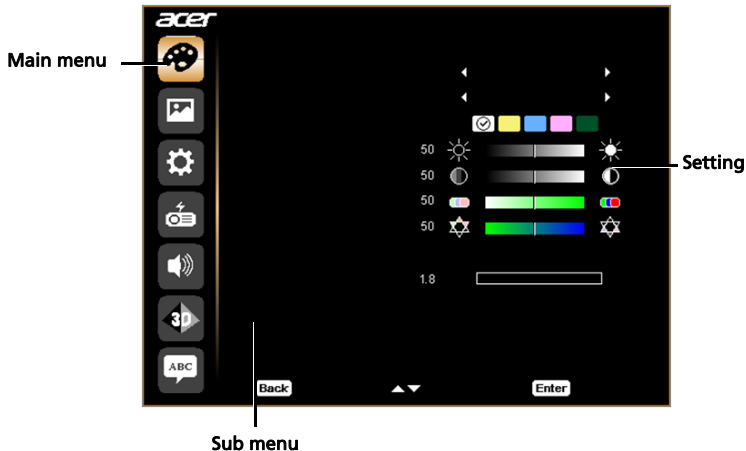

**Note 1:** Some of the following OSD settings may not be available. Please refer to the actual OSD of your projector.

**Note 2:** Functions vary depending on model definition.

# Color

|                        |   |
|------------------------|---|
| LumiSense <sup>+</sup> | <p>The light sensor of LumiSense+ technology can intelligently optimize the brightness and color saturation of projected image based on actual ambient light. The feature greatly enhances dark detail visibility and color saturation.</p> <ul style="list-style-type: none"> <li>• Off: For normal mode. (ambient light sensor is off)</li> <li>• Auto Bright: Light sensor is on to automatically detect ambient light and optimize the brightness and color saturation of projected image.</li> <li>• Dynamic Black: automatically optimize the display of dark movie scenes enabling them to be shown in incredible detail.</li> </ul>   |
| Display Mode           | <p>There are many factory presets optimized for various types of images.</p> <ul style="list-style-type: none"> <li>• Bright: For brightness optimization.</li> <li>• Presentation: For meeting presentation.</li> <li>• Standard: For common environment.</li> <li>• sRGB: standard RGB color space.</li> <li>• Game: For game content.</li> <li>• Movie: For brighter and general movie/video/photo playing.</li> <li>• Dark Cinema: For dark movie content.</li> <li>• Sport: For sport picture.</li> <li>• Rec. 709: standard Rec. 709 color space.</li> <li>• ISF Day: Calibrate and optimize the projection image based on bright environment by an ISF Certified technician.</li> <li>• ISF Night: Calibrate and optimize the projection image based on dark environment by an ISF Certified technician.</li> <li>• User: Memorize user's settings.</li> </ul> |
| Wall color             | <p>Use this function to choose a proper color according to the wall. There are several choices, including white, light yellow, light blue, pink, dark green. It will compensate the color deviation due to the wall color to show the correct image tone.</p>   |
| Brightness             | <p>Adjust the brightness of the image.</p> <ul style="list-style-type: none"> <li>• Press ◀ to darken the image.</li> <li>• Press ▶ to lighten the image.</li> </ul>  |
| Contrast               | <p>"Contrast" controls the difference between the lightest and darkest parts of the picture. Adjusting the contrast changes the amount of black and white in the image.</p> <ul style="list-style-type: none"> <li>• Press ◀ to decrease the contrast.</li> <li>• Press ▶ to increase the contrast.</li> </ul>  |
| Saturation             | <p>Adjusts a video image from black and white to fully saturated color.</p> <ul style="list-style-type: none"> <li>• Press ◀ to decrease the amount of color in the image.</li> <li>• Press ▶ to increase the amount of color in the image.</li> </ul>  |
| Tint                   | <p>Adjusts the color balance of red and green.</p> <ul style="list-style-type: none"> <li>• Press ◀ to increase the amount of green in the image.</li> <li>• Press ▶ to increase the amount of red in the image.</li> </ul>   |













|                   |   |
|-------------------|---|
| Color Temperature | Mode<br>Use this function to choose CT1, CT2 (Native), CT3, User mode.  |
|                   | R Gain<br>Adjusts the red gain for color temperature optimization.  |
|                   | G Gain<br>Adjusts the green gain for color temperature optimization.  |
|                   | B Gain<br>Adjusts the blue gain for color temperature optimization.   |
|                   | R Bias<br>Adjusts the red bias for color temperature optimization.  |
|                   | G Bias<br>Adjusts the green bias for color temperature optimization.  |
|                   | B Bias<br>Adjusts the blue bias for color temperature optimization.   |
| Gamma             | Effects the representation of dark scenery. With greater gamma value, dark scenery looks brighter.  |
| Advanced          | Ind. Color Management<br>Adjusts the red, green, blue, cyan, yellow and magenta colors.   |
|                   | Ind. Hue<br>Adjusts the color balance of red and green.   |
|                   | Ind. Saturation<br>Adjusts the selected color to be less or more saturated color.   |
|                   | Ind. Gain<br>Adjusts the selected color's contrast.   |
|                   | Brilliant Color<br>Produces an expanded on-screen color spectrum that delivers enhanced color saturation for bright, true-to-life images.   |
|                   | White Peaking<br>Increases the brightness of whites that are near 100%. (video sources only)  |
|                   | Film Mode<br>Sets the image optimized to 24-frame True Film mode.   |
|                   | Noise Reduction<br>Adjusts signal noise reduction. "0" means the noise reduction is off, ">0" increase noise reduction.   |
|                   | Black Extension<br>This ensures optimum black level for each analog source.   |
|                   | ISF<br><ol style="list-style-type: none"> <li>1. The certified ISF technician will calibrate and optimize the projection image according to your actual environment. The ISF input password will be kept by technician only.</li> <li>2. "ISF Day" and "ISF Night" will not be shown in display mode if projector equipped with ISF function has not been calibrated by an ISF certified technician. For more information, please go to ISF official website: <a href="https://www.imagingscience.com">https://www.imagingscience.com</a> and contact the dealer located in your country.</li> <li>3. The ISF calibration will be charged and guaranteed by ISF certified calibrator, and thereby Acer is not responsible for the calibration service.</li> </ol> |



**Note 1:** "Saturation" and "Tint" functions are not supported under computer or HDMI mode.

**Note 2:** Functions vary depending on model definition.

# Image

|                                      |  |
|--------------------------------------|--|
| Projection Mode                      | <ul style="list-style-type: none"> <li>  Front: The factory default setting.         </li> <li>  Rear: Reverses the image so you can project from behind a translucent screen.         </li> </ul>   |
| Projection Location                  | <ul style="list-style-type: none"> <li>  Auto: Automatically adjusts projection location of image.         </li> <li>  Desktop         </li> <li>  Ceiling: Turns the image upside down for ceiling-mounted projection.         </li> </ul>   |
| Aspect Ratio                         | <p>Use this function to choose your desired aspect ratio.</p> <ul style="list-style-type: none"> <li>Auto: Keep the image with original width-height ratio and maximize the image to fit native horizontal or vertical pixels.</li> <li>Full: Resize image to fit full screen by width (1280 pixels) and height (800 pixels).</li> <li>4:3: The image will be scaled to fit the screen and displayed using a 4:3 ratio.</li> <li>16:9: The image will be scaled to fit the width of the screen and the height adjusted to display the image using a 16:9 ratio.</li> <li>L.Box: Keep original signal aspect ratio and zoom in by 1.333 times.</li> </ul> |
| Auto Keystone                        | Automatically adjusts vertical image.  |
| Manual Keystone                      | <p>Adjust image distortion caused by tilting projection.</p> <div style="text-align: center;">  </div> <p>&lt;Note&gt; The Manual Keystone function is unavailable under Auto Keystone setting to "On".</p>   |
| Sharpness                            | <p>Adjusts the sharpness of the image.</p> <ul style="list-style-type: none"> <li>Press  to decrease the sharpness.</li> <li>Press  to increase the sharpness.</li> </ul>  |
| H. Position<br>(Horizontal position) | <ul style="list-style-type: none"> <li>Press  to move the image left.</li> <li>Press  to move the image right.</li> </ul>  |
| V. Position<br>(Vertical position)   | <ul style="list-style-type: none"> <li>Press  to move the image down.</li> <li>Press  to move the image up.</li> </ul>   |
| Frequency                            | "Frequency" changes the projector's refresh rate to match the frequency of your computer's graphics card. If you can see a vertical flickering bar in the projected image, use this function to make the necessary adjustments.  |
| Tracking                             | Synchronizes the signal timing of the projector with the graphics card. If you experience an unstable or flickering image, use this function to correct it.  |

|                  |  |
|------------------|--|
| HDMI Color Range | Adjust the color range of the HDMI image data to correct color display error. <ul style="list-style-type: none"> <li>• Auto: Automatically adjust by information from player.</li> <li>• Limited Range: Process the input image as limited color range data.</li> <li>• Full Range: Process the input image as full color range data.</li> </ul> |
| HDMI Scan Info   | Adjust the overscan ratio of the HDMI image on screen. <ul style="list-style-type: none"> <li>• Auto: Automatically adjust by information from player.</li> <li>• Underscan: Always no overscan on HDMI image.</li> <li>• Overscan: Always keep overscan on HDMI image.</li> </ul>   |



-----

**Note 1:** "H. Position", "V. Position", "Frequency" and "Tracking" functions are not supported under HDMI or Video mode.

**Note 2:** "HDMI Color Range" and "HDMI Scan Info" functions are only supported under HDMI mode.

**Note 3:** Functions vary depending on model definition.

# Setting

|                           |  |
|---------------------------|--|
| Startup Screen            | <p>Use this function to select your desired startup screen. If you change the setting, the changes will take effect when you exit the OSD menu.</p> <ul style="list-style-type: none"> <li>• Acer: The default startup screen of your Acer projector.</li> <li>• User: Use memorize picture from "Screen Capture" function.</li> </ul>   |
| Screen Capture            | <p>Use this function to customize the startup screen. To capture the image that you want to use as the startup screen, follow the instructions below.</p> <p>Notice:<br/>Before proceeding with the following steps, make sure that the "Keystone" is set to the default value 0.</p> <ul style="list-style-type: none"> <li>• Press "Screen Capture" to customize the startup screen.</li> <li>• Pop message to suggest user to input native source. The "resolution" shown in the text is based on native timing. Press "Start" to go next UI; press "Back" to previous UI .</li> <li>• A dialog box appears to confirm the action. Show a message: Adjust the picture size to fit in the red frame and system will capture your image after pressing "ENTER". Choose "ENTER" to use the current image as your customized startup screen. Choose "Back" to cancel the screen capture and exit the onscreen display (OSD).</li> <li>• A message appears, stating that the screen capture is in progress.</li> <li>• When the screen capture is finished, the message disappears and the original display is shown.</li> <li>• The customized startup screen takes effect when there is a new input signal or when you restart the projector.</li> </ul> |
| Source Lock               | <p>When Source Lock is turned "Off", the projector will search for other signals if the current input signal is lost. When Source Lock is turned "On", it will "lock" the current source channel unless you press "Source" button on the remote control for the next channel.</p>  |
| Closed Caption            | <p>Selects a preferred closed captioning mode from CC1, CC2, CC3, CC4, (CC1 displays captions in the primary language in your area). Select "Off" to turn off the captioning feature. This function is only available when a composite video or S-Video input signal is selected and its system format is NTSC.</p> <p>&lt;Note&gt; Set your screen aspect ratio to 4:3. This function is not available when the aspect ratio is "16:9" or "Auto" .</p>  |
| DC 5V Out (Type 1 series) | <p>Default is "On". Choose "Off" to Disable DC 5V OUT connection.</p> <p>&lt;Note&gt;</p> <ol style="list-style-type: none"> <li>1. DC 5V Out is not supported while in standby mode.</li> <li>2. That two or about of MHL, Internal 5V, DC 5V Out port supply power are not supported. And, MHL is at the top priority if three of them are occupied, and grays out DC 5V Out (OSD) &amp; Internal 5V (OSD) while MHL enables.</li> <li>3. DC 5V Out (OSD) sets to off automatically while Internal 5V (OSD) switches to On, and vice versa.</li> </ol>   |
| DC 5V Out (Type 2 series) | <p>Default is "On". Choose "Off" to Disable DC 5V OUT connection.</p> <p>&lt;Note&gt;</p> <ol style="list-style-type: none"> <li>1. If users want to use the "PgUp" or "PgDn" buttons, change "DC 5V Out" from "On" to "Off".</li> <li>2. 5V/1A power output if MHL source is not detected.</li> </ol> <p>Warning! The DC 5V Out may happen power conflict if connecting to PC and result in electric shock and/or injury.</p> <ol style="list-style-type: none"> <li>3. DC 5V Out is not supported while in standby mode.</li> </ol>  |



|                   |   |
|-------------------|---|
| Internal 5V       | <p>Default is "Off". Switch On to supply 5V power for both of power on mode and standby mode.</p> <p>&lt;Note&gt;</p> <ol style="list-style-type: none"> <li>Before doing OSD Reset: projector detects and shows that inner HDMI 2/MHL port after being plugged by non-MHL dongle (ex: Chromecast).</li> <li>After doing OSD Reset: If inner HDMI dongle existd and Internal 5V (OSD) is On simultaneously, Internal 5V (OSD) will be set as On and DC 5V Out (OSD) will be set as Off automatically after doing OSD Reset. (Since inner HDMI dongle isn't given power by projector causing inner dongle's signal is lost and cannot be detected by projector)</li> </ol>   |
| VGA OUT (Standby) | Default is "Off". Choose "On" to enable VGA OUT connection.   |
| HDMI CEC          | Default is "Off". Select "On" to enable HDMI CEC function.  |
| Reset             | Press the "ENTER" button and choose "Yes" to return the parameters on all menus to the factory default settings.  |
| Security          | <p><b>Security</b></p> <p>This projector provides a useful security function for the administrator to manage usage of the projector .</p> <p>Press "ENTER" to change the "Security" setting. If the security function is enabled, your must enter the "Administrator Password" first before changing the security settings.</p> <ul style="list-style-type: none"> <li>Select "On" to enable the security function. The user has to enter a password to operate the projector. Please refer to the "User Password" section for details.</li> <li>If "Off" is selected, then the user can turn on the projector without password.</li> </ul> <p><b>Timeout(Min.)</b></p> <p>Once "Security" is activated to "On", the administrator can set timeout function.</p> <ul style="list-style-type: none"> <li>Press ◀ or ▶ to select the timeout interval.</li> <li>The range is from 10 minute to 990 minutes.</li> <li>When the time is up, the projector will prompt the user to enter the password again.</li> <li>The factory default setting of "Timeout(Min.)" is "Off".</li> <li>Once the security function is enabled, the projector will request user to enter password when switch on the projector . Both "User Password" and "Administrator Password" can be accepted for this dialogue.</li> </ul> <p><b>User Password</b></p> <ul style="list-style-type: none"> <li>Press "ENTER" to setup or change the "User Password".</li> <li>Press number keys to set your password on the remote control and press "ENTER" to confirm.</li> <li>Press ◀ to delete character.</li> <li>Enter the password when you see "Confirm Password" displayed.</li> <li>The password should be between 4 and 8 characters long.</li> <li>If you select "Request password only when plugging the power cord in.", the projector will prompt the user to enter the password every time the power cord is plugged.</li> <li>If you select "Always request password while projector turns on.", the user has to enter the password every time when the projector is turned on.</li> </ul> |

|  |  |
|--|--|
|  | <p><b>Administrator Password</b></p> <p>The "Administrator Password" can be used in both the "Enter Administrator Password" and "Enter Password" dialog boxes.</p> <ul style="list-style-type: none"> <li>• Press "ENTER" to change the "Administrator Password".</li> <li>• The factory default of "Administrator Password" is "1234".</li> </ul> <p>If you forgot your administrator password, do the following to retrieve the administrator password:</p> <ul style="list-style-type: none"> <li>• An unique 6-digit "Universal Password" which is printed on the Security Card (please check accessory in the box). This unique password is the number which will be accepted by projector anytime no matter what the Administrator Password is.</li> <li>• If losing this security card and number, please contact with an Acer service center.</li> </ul> |
|  | <p><b>Lock to user startup screen</b></p> <p>Default Lock User Startup Screen is "Off". If lock user startup screen is "On", users cannot change startup screen anymore and avoid other users change that arbitrarily. Choose "Off" to unlock startup screen.</p>  |



.....

**Note1:** Functions vary depending on model definition.  
**Note2:** Internal 5V not applicable for type 2 series.

## Management



|                             |   |
|-----------------------------|---|
| ECO Mode                    | Choose "On" to dim the projector lamp which will lower power consumption, extend the lamp life and reduce noise. Choose "Off" to return normal mode.  |
| High Altitude               | Choose "On" to turn on High Altitude mode. Operate the fans at full speed continuously to allow for proper high altitude cooling of the projector.  |
| Turn Off Mode               | <ul style="list-style-type: none"> <li>• Instant Off: Shuts down the projector without fan cooling.</li> <li>• Instant Resume: Resumes the system when the Power button is pressed again within 2 minutes.</li> </ul> |
| Auto Shutdown               | The projector will automatically shutdown when there is no signal input after the allocated time. (default is 15 minutes)   |
| Menu Display Time (Seconds) | Choose the OSD menu display time. (Default is 15 seconds). Select "Manual" to turn off main menu/one direct-key menu manually by user.  |
| AC Power On                 | Choose "On" to power on projector while AC power plug in.   |
| Lamp Hour Elapse            | Displays the lamp's elapsed operating time (in hours).  |
| Lamp Reminding              | Activate this function to display a reminder to change the lamp 30 hours before its expected end-of-life.   |
| Lamp Hour Reset             | Press the "ENTER" button and choose "Yes" to turn the lamp hour counter to 0 hours.   |



.....

**Note:** Functions vary depending on model definition.

## Audio

|        |  |
|--------|--|
| Volume | <ul style="list-style-type: none"> <li>• Press  to decrease the volume.</li> <li>• Press  to increase the volume.</li> </ul> |
| Mute   | <ul style="list-style-type: none"> <li>• Choose "On" to mute the volume.</li> <li>• Choose "Off" to restore the volume.</li> </ul>   |



.....

**Note:** Functions vary depending on model definition.

## 3D

|                    |   |
|--------------------|---|
| 3D                 | Choose "On" to enable DLP 3D function. <ul style="list-style-type: none"> <li>• On: Choose this item while using DLP 3D glasses, 120Hz 3D capable graphics cards and HQFS format file or DVD with corresponding SW player.</li> <li>• Off: Turn off 3D mode.</li> </ul> |
| 3D Format          | If the 3D content is not displayed correctly, you can select a 3D format that suits the 3D content you are viewing and obtain the best result.  |
| 24P 3D             | Choose "96Hz" or "144Hz" to compatible with 3D glasses.   |
| 3D L/R Invert      | If you see a discrete or overlapping image while wearing DLP 3D glasses, you may need to execute "Invert" to get best match of left/right image sequence to get the correct image (for DLP 3D).   |
| 3D Warning Message | Choose "On" to display the 3D warning message.    |



.....

**Note 1:** It needs correct settings on graphic card 3D application program for correct 3D display.

**Note 2:** The SW players, such as Stereoscopic Player and DDD TriDef Media Player can support 3D format files. You can download these three players on web page below,

- Stereoscopic Player (Trial):

[http://www.3dtv.at/Downloads/Index\\_en.aspx](http://www.3dtv.at/Downloads/Index_en.aspx)

- DDD TriDef Media Player (Trial):





<http://www.tridef.com/download/TriDef-3-D-Experience-4.0.2.html>

**Note 3:** "3D L/R Invert" is only available when 3D is enabled.

**Note 4:** There has reminder screen if 3D still enable when power on projector. Please adjust setting depended on your purpose.

**Note 5:** WUXGA model 24P 3D cannot be scaling due to TI ASIC buffer memory limitation, and once detect 24P 3D (96Hz or 144Hz) inputs, Aspect Ratio / HDMI Scan Info will be gray out, also HIDE will be not supported.

# Language

|          |  |
|----------|--|
| Language | <p>Choose the multilingual OSD menu. Use the     key to select your preferred menu language.</p> <ul style="list-style-type: none"><li>• Press "ENTER" to confirm the selection.</li></ul> |
|----------|--|

# Appendices

## Troubleshooting

If you experience a problem with your Acer projector, refer to the following troubleshooting guide. If the problem persists, please contact your local reseller or service center.



### Image Problems and Solutions

| # | Problem  | Solution  |
|---|--|---|
| 1 | No image appears onscreen  | <ul style="list-style-type: none"> <li>• Connected as described in the "Getting Started" section.</li> <li>• Ensure none of the connector pins are bent or broken.</li> <li>• Check if the projector lamp has been securely installed. Please refer to the "Replacing the Lamp" section.</li> <li>• Make sure you have removed the lens cap and the projector is switched on.</li> </ul>  |
| 2 | Partial, scrolling or incorrectly displayed image (for PC (Windows 2000/XP/Vista/Windows 7/Windows 8)) | <ul style="list-style-type: none"> <li>• For an incorrectly displayed image:             <ul style="list-style-type: none"> <li>• Open "My Computer", open the "Control Panel", and then double-click the "Display" icon.</li> <li>• Select the "Settings" tab.</li> <li>• Verify that your display resolution setting is lower than or equal to WUXGA-RB (1920 x 1200).</li> <li>• Click the "Advanced Properties" button.</li> </ul> </li> </ul> <p>If the problem still appears, change the monitor display you are using and follow the steps below:</p> <ul style="list-style-type: none"> <li>• Verify that the resolution setting is lower than or equal to WUXGA-RB (1920 x 1200).</li> <li>• Click the "Change" button under the "Monitor" tab.</li> <li>• Click "Show all devices". Next, select "Standard monitor types" under the SP box, and choose the resolution mode you need under the "Models" box.</li> <li>• Verify that the resolution setting of the monitor display is lower than or equal to WUXGA-RB (1920 x 1200).</li> </ul> |

|   |   |  |
|---|---|--|
| 3 | Partial, scrolling or incorrectly displayed image (For notebooks)       | <ul style="list-style-type: none"> <li>• For an incorrectly displayed image:             <ul style="list-style-type: none"> <li>• Follow the steps for item 2 (above) to adjust the resolution of your computer.</li> <li>• Press the toggle output settings. Example: [Fn]+[F4], Compaq [Fn]+[F4], Dell [Fn]+[F8], Gateway [Fn]+[F4], IBM [Fn]+[F7], HP [Fn]+[F4], NEC [Fn]+[F3], Toshiba [Fn]+[F5]</li> </ul> </li> <li>• If you experience difficulty changing resolutions or your monitor freezes, restart all equipment including the projector.</li> </ul>                   |
| 4 | The screen of the notebook computer is not displaying your presentation | <ul style="list-style-type: none"> <li>• If you are using a Microsoft® Windows® based notebook: Some notebook PCs may deactivate their own screens when a second display device is in use. Each has a different way to be reactivated. Refer to your computer's manual for detailed information.</li> <li>• If you are using an Apple® Mac® OS based notebook: In System Preferences, open Display and select Video Mirroring "On".</li> </ul>   |
| 5 | Image is unstable or flickering   | <ul style="list-style-type: none"> <li>• Adjust the "Tracking" to correct it. Refer to the "Image" section for more information.</li> <li>• Change the display color depth settings on your computer.</li> </ul>   |
| 6 | Image has vertical flickering bar                                       | <ul style="list-style-type: none"> <li>• Use "Frequency" to make an adjustment. Refer to the "Image" section for more information.</li> <li>• Check and reconfigure the display mode of your graphics card to make it compatible with the projector.</li> </ul>  |
| 7 | Image is out of focus   | <ul style="list-style-type: none"> <li>• Make sure the lens cap is removed.</li> <li>• Adjusts the focus ring on the projector lens.</li> <li>• Make sure the projection screen is within the required distance of 3.3 to 29.7 feet (1.0 to 9.1 meters) (XGA series) / 3.3 to 25.2 feet (1.0 to 7.7 meters) (WXGA series) / 3.3 to 33.8 feet (1.0 to 10.3 meters) (720p series) / 3.3 to 24.6 feet (1.0 to 7.5 meters) (1080p series) from the projector. Refer to the "How to get a preferred image size by adjusting distance and zoom" section for more information.</li> </ul> |
| 8 | Image is stretched when displaying a "widescreen" DVD title             | <p>When you play a DVD encoded in anamorphic or 16:9 aspect ratio you may need to adjust the following settings:</p> <ul style="list-style-type: none"> <li>• If you play a 4:3 format DVD title, please change the format to 4:3 in the projector OSD.</li> <li>• If the image is still stretched, you will also need to adjust the aspect ratio. Set up the display format to 16:9 (wide) aspect ratio on your DVD player.</li> <li>• If you play an Letterbox (LBX) format DVD title, please change the format to Letterbox (LBX) in the projector OSD.</li> </ul>              |

|    |                                 |   |
|----|---------------------------------|---|
| 9  | Image is too small or too large | <ul style="list-style-type: none"><li>• Adjust the zoom ring on the projector.</li><li>• Move the projector closer to or further from the screen.</li><li>• Press "MENU" on the remote control. Go to "Image --&gt; Aspect Ratio" and try different settings or press "RATIO" on the remote control to adjust directly.</li></ul> |
| 10 | Image has slanted sides         | <ul style="list-style-type: none"><li>• If possible, reposition the projector so that it is centered on the screen.</li><li>• Press the "Keystone <math>\Delta</math> / <math>\square</math>" button on the remote control until the sides are vertical.</li></ul>  |
| 11 | Image is reversed               | <ul style="list-style-type: none"><li>• Select "Image --&gt; Projection Mode" on the OSD and adjust the projection direction.</li></ul>   |

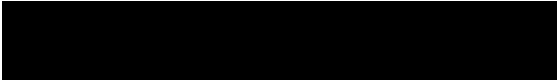
## OSD Messages

| # | Condition | Message Reminder   |
|---|-----------|--|
| 1 | Message   | <ul style="list-style-type: none"> <li>• Fan Fail - the system fan is not working.</li> </ul>  <ul style="list-style-type: none"> <li>• Projector Overheated - the projector has exceeded its recommended operating temperature and must be allowed to cool down before it may be used. Please check the following message.</li> </ul>  <p>Please also check the dust filters if they are installed. If the dust filter is clogged with dust, please clean it. Please refer to "Cleaning and replacing the dust filters (Option)" for details.</p> <ul style="list-style-type: none"> <li>• Replace the lamp - the lamp is about to reach its maximum lifetime. Prepare to replace it soon.</li> </ul>  |

## Problems with the Projector

| # | Condition                                      | Solution   |
|---|--|--|
| 1 | The projector stops responding to all controls | If possible, turn off the projector, then unplug the power cord and wait at least 30 seconds before reconnecting power.  |
| 2 | Lamp burns out or makes a popping sound        | When the lamp reaches the end of its useful life, it will burn out and may make a loud popping sound. If this happens, the projector will not turn on until the lamp module has been replaced. To replace the lamp, follow the procedures in the "Replacing the Lamp" section. |



# LED & Alarm Definition Listing

## LED Messages

| Message  | Lamp_LED              | Temp_LED              | Power LED             |                |
|--|-----------------------|-----------------------|-----------------------|----------------|
|  | Red                   | Red                   | Red                   | Blue           |
| Input power plug                                   | Flash ON to OFF 100ms | Flash ON to OFF 100ms | Flash ON to OFF 100ms | --             |
| Standby  | --                    | --                    | ON                    | --             |
| Power button ON                                    | --                    | --                    | --                    | ON             |
| Lamp retry   | --                    | --                    | --                    | Quick Flashing |
| Power off (Cooling state)                          | --                    | --                    | Quick Flashing        | --             |
| Power button OFF (cooling completed; standby mode) | --                    | --                    | ON                    | --             |
| Error (thermal failure)                            | --                    | ON                    | --                    | ON             |
| Error (fan lock)                                   | --                    | Quick Flashing        | --                    | ON             |
| Error (lamp breakdown)                             | ON                    | --                    | --                    | ON             |
| Error (color wheel fail)                           | Quick Flashing        | --                    | --                    | ON             |

## How to install the Inner Dongle

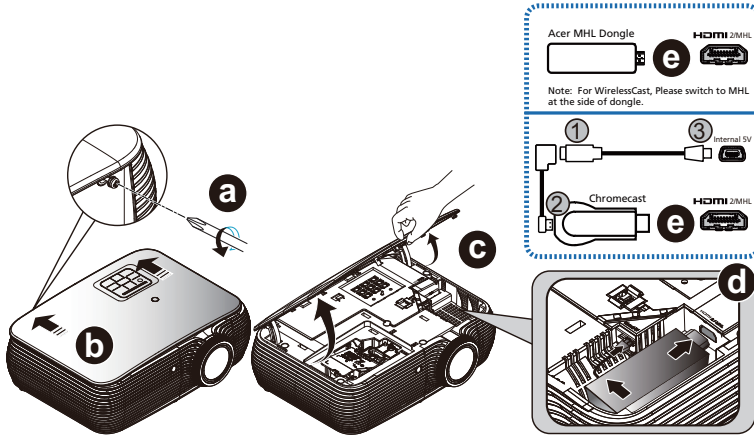

If you install Acer MHL Dongle (WirelessCAST/WirelessHD-Kit) or Chromecast, follow the below steps:

- A Use a screwdriver to remove the screw from the cover. (Illustration #a)
- B Push up the cover. (Illustration #b)
- C Remove the cover. (Illustration #c)
- D Connect the cables. (Illustration #d) <For Chromecast Only>
  - (1) Connect the Micro USB (male) to Micro USB (female) 50 mm cable to Micro USB to Mini USB 80 mm cable (Illustration #1);
  - (2) Connect the Micro USB (male) to Micro USB (female) 50 mm cable or Micro USB to Mini USB 80 mm cable to Dongle (Illustration #2);
  - (3) Connect the Micro USB to Mini USB 80 mm cable to Internal 5V port on the projector (Illustration #3);
- E Connect the Dongle to HDMI 2/MHL port on the projector. (Illustration #e)



**Note:** Chromecast is available for the model with internal 5V.

## Cleaning and replacing the dust filters (Option)

### Cleaning the dust filters

Clean the dust filters after every 1000 hours of use. If they are not cleaned periodically, they can become clogged with dust, preventing proper ventilation. This can cause overheating and damage the projector.

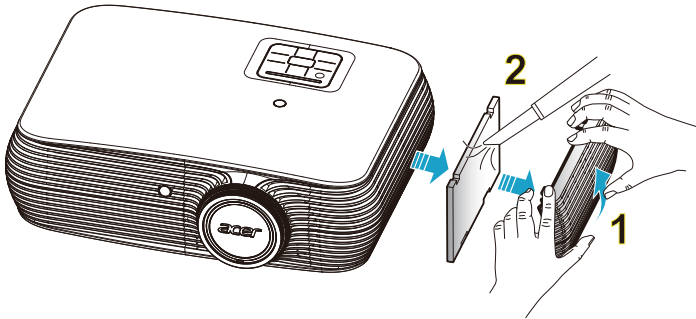

Follow these steps:

- 1 Turn the projector off. Wait for the Power LED to stop flashing then unplug the power cord.
- 2 Allow the projector at least 30 mins to cool down.
- 3 Pull out the dust filter. (Illustration #1)
- 4 To clean the dust filters, use a small vacuum cleaner designed for computers and other office equipment. (Illustration #2)
- 5 If the dirt is difficult to remove or the filter is broken, please contact your local dealer or service center to obtain a new filter.

## Replacing the Lamp

Use a screwdriver to remove the screw(s) from the cover, and then pull out the lamp.

The projector will detect the lamp life. You will be shown a warning message "**Lamp is approaching the end of its useful life in full power operation. Replacement suggested!**" When you see this message, change the lamp as soon as possible. Make sure the projector has been cooling down for at least 30 minutes before changing the lamp.



**Warning:** The lamp compartment is hot! Allow it to cool down before changing the lamp.

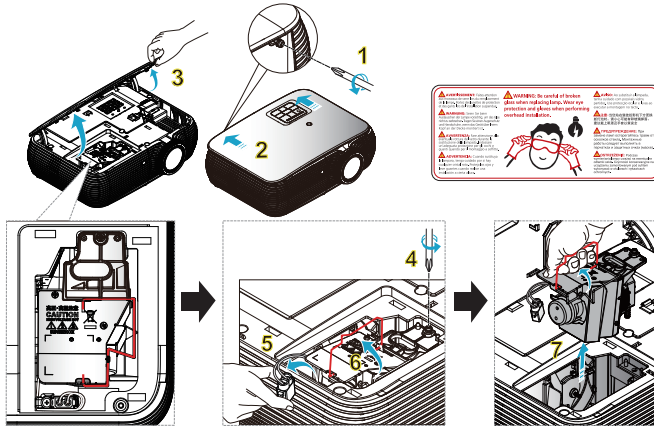

### To Change the Lamp

Turn off the projector by pressing the Power button.

Allow the projector at least 30 minutes to cool down.

Disconnect the power cord.

- 1 Use a screwdriver to remove the screw from the cover. (Illustration #1)  
Push to the direction of the arrow. (Illustration #2)  
Push up the cover. (Illustration #3)
- 2 Remove the screw that secure the lamp module. (Illustration #4)  
Pull out the lamp plug. (Illustration #5)  
Lift the handle so that it stands up. (Illustration #6)
- 3 Lift the handle so that it stands up. Pull out the lamp module by force. (Illustration #7)

To replace the lamp module, use a new lamp and reverse the above steps.



**Warning:** To reduce the risk of personal injury, do not drop the lamp module or touch the lamp bulb. The bulb may shatter and cause injury if it is dropped.

## Ceiling Mount Installation

If you wish to install the projector using a ceiling mount, please refer to the steps below:

- 1 Drill four holes into a solid, structural ceiling member, and secure the ceiling mount base to the ceiling.

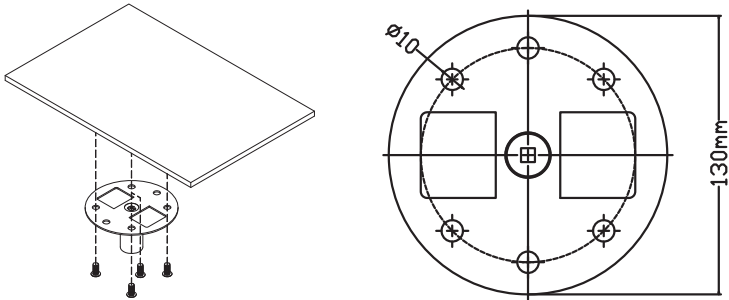

- 2 Choose the length combination based on actual environment. (CM-01S doesn't include Type 2 and Type 3.)

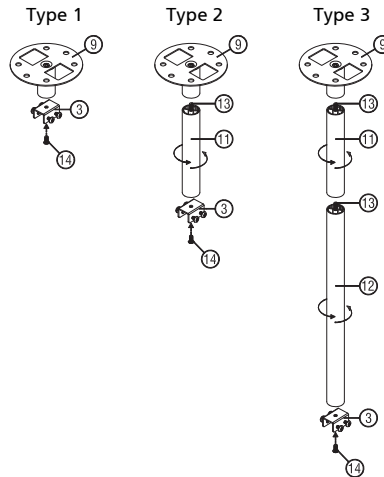

- 3 Type 1:  
For the standard size use three bracket screws to mount the projector to the ceiling mount bracket.  
Type 2 and Type 3:  
Alternatively, for the larger size, use the sliding extensions for more supports.

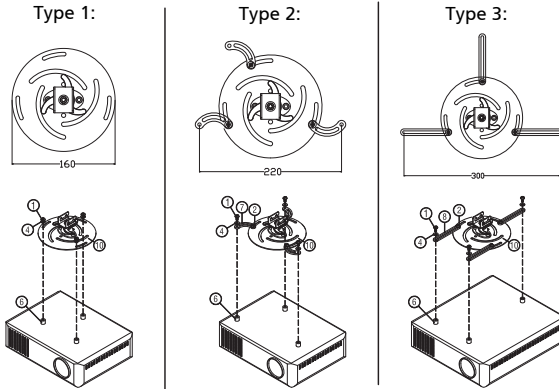

**Note:** It is recommended that you keep a reasonable space between the bracket and the projector to allow for proper heat distribution.

- 4 Connect the main body connector to the projector bracket (illustration 1), and then screw up four screws (illustration 2).

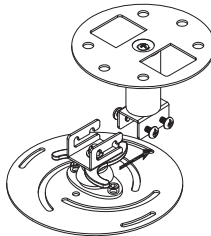

Illustration 1

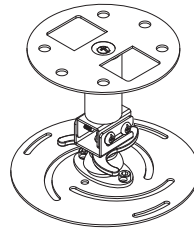
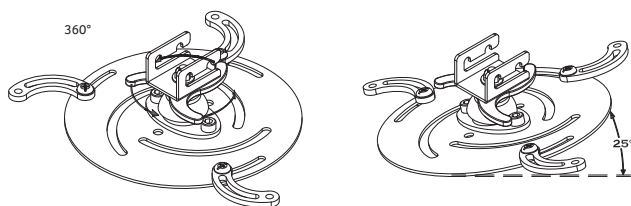

Illustration 2

- 5 Adjust the angle and positioning as necessary.



| Screw Type B  |             | Washer Type |       |
|---------------|-------------|-------------|-------|
| Diameter (mm) | Length (mm) | Large       | Small |
| 4             | 25          | V           | V     |

SCREW SPEC. M4 x 25 mm

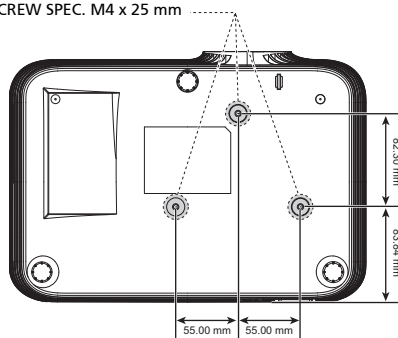

# Specifications

The specifications listed below are subject to change without notice. For final specs, please refer to Acer's published marketing specifications.

| Projection system      | DLP®  |
|------------------------|---|
| Resolution             | <ul style="list-style-type: none"> <li>A1200/B110/CE-X10/C11X/AX331 series: 1024x768 XGA resolution</li> <li>A1300W/B120/CE-W10/C11W/AW331 series: 1280x800 WXGA resolution</li> <li>H5382BD/E232/HE-722 series: 1280x720 720p resolution</li> <li>A1500/B150/CE-810/H6511BD/H6512BD/E146D/HE-805J/L552/V62/H6510BD+/P1502 series: 1920x1080 1080p resolution</li> <li>Maximum: UXGA (1600 x 1200), WSXGA+ (1680x1050), 1080p(1920x1080), WUXGA-RB (1920 x 1200)</li> </ul> |
| Computer compatibility | IBM PC and compatibles, Apple Macintosh, iMac and VESA standards: SXGA, XGA, VGA, SVGA, SXGA+, WXGA, WXGA+, WSXGA +   |
| Video compatibility    | NTSC (3.58/4.43), PAL (B/D/G/H/I/M/N), SECAM (B/D/G/K/K1/L), HDTV (720p, 1080i, 1080p), EDTV (480p, 576p), SDTV (480i, 576i)  |
| Aspect ratio           | Auto, Full, 4:3, 16:9, L.Box  |
| Displayable colors     | 1.07 billion colors   |
| Optical zoom ratio     | <ul style="list-style-type: none"> <li>A1200/B110/CE-X10/C11X/AX331/A1300W/B120/CE-W10/C11W/AW331/A1500/B150/CE-810/H6511BD/H6512BD/E146D/HE-805J/L552/V62/H6510BD+/P1502 series: 1.3X</li> <li>H5382BD/E232/HE-722 series: 1.1X</li> </ul>   |
| Throw ratio            | <ul style="list-style-type: none"> <li>A1200/B110/CE-X10/C11X/AX331 series: 1.49 ~ 1.93 (66" @2m)</li> <li>A1300W/B120/CE-W10/C11W/AW331 series: 1.19 ~ 1.54 (78" @2m)</li> <li>H5382BD/E232/HE-722 series: 1.54 ~ 1.72 (100" @3.4m)</li> <li>A1500/B150/CE-810/H6511BD/H6512BD/E146D/HE-805J/L552/V62/H6510BD+/P1502 series: 1.13 ~ 1.47 (100" @2.5m)</li> </ul>   |
| Projection lens        | <ul style="list-style-type: none"> <li>A1200/B110/CE-X10/C11X/AX331/A1300W/B120/CE-W10/C11W/AW331/A1500/B150/CE-810/H6511BD/H6512BD/E146D/HE-805J/L552/V62/H6510BD+/P1502 series:<br/>F = 2.50~2.78,<br/>f = 16.91mm ~ 21.60mm,<br/>Manual Zoom &amp; Focus</li> <li>H5382BD/E232/HE-722 series:<br/>F = 2.41 ~ 2.53,<br/>f = 21.85mm ~ 24.00mm,<br/>Manual Zoom &amp; Focus</li> </ul>   |



|                                   |  |
|-----------------------------------|--|
| Projection screen size (diagonal) | <ul style="list-style-type: none"> <li>• A1200/B110/CE-X10/C11X/AX331 series:<br/>25" ~ 300" (65cm ~ 762cm)</li> <li>• A1300W/B120/CE-W10/C11W/AW331 series:<br/>30" ~ 300" (76cm ~ 762cm)</li> <li>• H5382BD/E232/HE-722 series:<br/>26" ~ 300" (66cm ~ 762cm)</li> <li>• A1500/B150/CE-810/H6511BD/H6512BD/E146D/HE-805J/L552/V62/H6510BD+/P1502 series:<br/>31" ~ 300" (78cm ~ 762cm)</li> </ul>      |
| Projection distance               | <ul style="list-style-type: none"> <li>• A1200/B110/CE-X10/C11X/AX331 series:<br/>1.0m ~ 9.1m (3.3' ~ 29.7')</li> <li>• A1300W/B120/CE-W10/C11W/AW331 series:<br/>1.0m ~ 7.7m (3.3' ~ 25.2')</li> <li>• H5382BD/E232/HE-722 series:<br/>1.0m ~ 10.3m (3.3" ~ 33.8')</li> <li>• A1500/B150/CE-810/H6511BD/H6512BD/E146D/HE-805J/L552/V62/H6510BD+/P1502 series:<br/>1.0m ~ 7.5m (3.3' ~ 24.6')</li> </ul> |
| Horizontal scan rate              | 15 - 100 kHz   |
| Vertical refresh scan rate        | 24 - 120 Hz  |
| Lamp type                         | 195 W user-replaceable lamp  |
| Keystone correction               | ±40 degrees  |
| Audio                             | <ul style="list-style-type: none"> <li>• A1200/B110/CE-X10/C11X/AX331/A1300W/B120/CE-W10/C11W/AW331/A1500/B150/CE-810/H6511BD series: Internal speaker with 10 W x 1 output</li> <li>• H5382BD/E232/HE-722/H6512BD/E146D/HE-805J/L552/V62/H6510BD+/P1502 series: Internal speaker with 3 W x 1 output</li> </ul>   |
| Weight                            | <ul style="list-style-type: none"> <li>• A1200/B110/CE-X10/C11X/AX331/A1300W/B120/CE-W10/C11W/AW331/A1500/B150/CE-810/H6511BD series: 2.7 Kg (5.9 lbs)</li> <li>• H5382BD/E232/HE-722 series: 2.4 Kg (5.3 lbs)</li> <li>• H6512BD/E146D/HE-805J/L552/V62/H6510BD+/P1502 series: 2.65 Kg (5.8 lbs)</li> </ul>   |
| Dimensions (W x D x H)            | 315 mm X 214 mm X 97.6 mm (12.4" x 8.4" x 3.8")  |
| Digital zoom                      | 2X   |
| Power supply                      | AC input 100 - 240 V auto-switching power supply   |
| Power consumption                 | Normal mode: 235W ± 10% @ 110VAC<br>ECO mode: 195W ± 10% @ 110VAC<br>Standby mode < 0.5W   |
| Operating temperature             | 0°C to 40°C / 32°F to 104°F  |
| Standard package contents         | <ul style="list-style-type: none"> <li>• AC power cord x1</li> <li>• VGA cable x1</li> <li>• Remote control x1</li> <li>• Battery x1 (for remote control) (option)</li> <li>• User's guide (CD-ROM) x1</li> <li>• Quick start guide x1</li> <li>• Security card x1 (option)</li> <li>• Dust filters x1 (option)</li> <li>• Carrying case x1 (option)</li> </ul>  |

| I/O connectors            | A1200/B110/CE-X10/<br>C11X/AX331/<br>A1300W/B120/CE-W10/<br>C11W/AW331/<br>A1500/B150/CE-810/<br>H6511BD | H5382BD/E232/<br>HE-722 | H6512BD/E146D/<br>HE-805J/<br>L552/V62/<br>H6510BD+/P1502 |
|---------------------------|--|-------------------------|---|
| Power socket              | V  | V                       | V   |
| VGA IN                    | X  | V                       | V   |
| VGA IN 1                  | V  | X                       | X   |
| VGA IN 2                  | V  | X                       | X   |
| VGA output                | V  | X                       | X   |
| Composite video           | V  | V                       | V   |
| HDMI                      | V  | V                       | V   |
| HDMI/MHL                  | X  | V                       | X   |
| RS232                     | V  | V                       | V   |
| 3.5 mm audio jack input   | X  | V                       | V   |
| 3.5 mm audio jack input 1 | V  | X                       | X   |
| 3.5 mm audio jack input 2 | V  | X                       | X   |
| 3.5 mm audio jack output  | V  | V                       | V   |
| 5V DC output              | V  | V                       | V   |
| Inner I/O Connectors      |  |                         |   |
| HDMI/MHL                  | V  | X                       | V   |
| Internal 5V x1            | V  | X                       | X   |



.....  
**Note:** Design and specifications are subject to change without notice.

# Compatibility modes

## A. VGA Analog

### 1 VGA Analog - PC Signal

| Modes         | Resolution | V.Frequency [Hz] | H.Frequency [KHz] |
|---------------|------------|------------------|-------------------|
| VGA           | 640x480    | 60               | 31.5              |
|               | 640x480    | 72               | 37.9              |
|               | 640x480    | 75               | 37.5              |
|               | 640x480    | 85               | 43.3              |
|               | 640x480    | 120              | 61.9              |
| SVGA          | 800x600    | 56               | 35.1              |
|               | 800x600    | 60               | 37.9              |
|               | 800x600    | 72               | 48.1              |
|               | 800x600    | 75               | 46.9              |
|               | 800x600    | 85               | 53.7              |
| XGA           | 800x600    | 120              | 77.4              |
|               | 1024x768   | 60               | 48.4              |
|               | 1024x768   | 70               | 56.5              |
|               | 1024x768   | 75               | 60.0              |
|               | 1024x768   | 85               | 68.7              |
| SXGA          | 1024x768   | 120              | 99.0              |
|               | 1152x864   | 70               | 63.8              |
|               | 1152x864   | 75               | 67.5              |
|               | 1152x864   | 85               | 77.1              |
|               | 1280x1024  | 60               | 64.0              |
| QuadVGA       | 1280x1024  | 72               | 77.0              |
|               | 1280x1024  | 75               | 80.0              |
|               | 1280x1024  | 85               | 91.1              |
|               | 1280x960   | 60               | 60.0              |
|               | 1280x960   | 75               | 75.2              |
| SXGA+         | 1400x1050  | 60               | 65.3              |
| UXGA          | 1600x1200  | 60               | 75.0              |
| PowerBook G4  | 640x480    | 60               | 31.4              |
| PowerBook G4  | 640x480    | 66.6(67)         | 34.9              |
| PowerBook G4  | 800x600    | 60               | 37.9              |
| PowerBook G4  | 1024x768   | 60               | 48.4              |
| PowerBook G4  | 1152x870   | 75               | 68.7              |
| PowerBook G4  | 1280x960   | 75               | 75.0              |
| i Mac DV (G3) | 1024x768   | 75               | 60.0              |

## 2 VGA Analog - Extended Wide timing

| Modes  | Resolution           | V.Frequency [Hz] | H.Frequency [KHz] |
|--------|----------------------|------------------|-------------------|
| WXGA   | 1280x768             | 60               | 47.8              |
|        | 1280x768             | 75               | 60.3              |
|        | 1280x768             | 85               | 68.6              |
|        | 1280x720             | 60               | 44.8              |
|        | 1280x720             | 120              | 92.9              |
|        | 1280x800             | 60               | 49.6              |
|        | 1280x800             | 119.909          | 101.6             |
| WSXGA+ | 1920x1200            | 60               | 74                |
|        | 1440x900             | 60               | 59.9              |
|        | 1680x1050            | 60               | 65.3              |
| WUXGA  | 1920x1080<br>(1080P) | 60               | 67.5              |
|        | 1366x768             | 60               | 47.7              |
|        | 1920x1200-RB         | 59.94            | 74.04             |

## 3 VGA Analog -Component Signal

| Modes | Resolution         | V.Frequency [Hz] | H.Frequency [KHz] |
|-------|--------------------|------------------|-------------------|
| 480i  | 720x480 (1440x480) | 59.94 (29.97)    | 15.7              |
| 576i  | 720x576 (1440x576) | 50(25)           | 15.6              |
| 480p  | 720x480            | 59.94            | 31.5              |
| 576p  | 720x576            | 50               | 31.3              |
| 720p  | 1280x720           | 60               | 45.0              |
| 720p  | 1280x720           | 50               | 37.5              |
| 1080i | 1920x1080          | 60(30)           | 33.8              |
| 1080i | 1920x1080          | 50(25)           | 28.1              |
| 1080p | 1920x1080          | 23.97/24         | 27.0              |
| 1080p | 1920x1080          | 60               | 67.5              |
| 1080p | 1920x1080          | 50               | 56.3              |

## B. HDMI Digital

### 1 HDMI - PC Signal

| Modes | Resolution | V.Frequency [Hz] | H.Frequency [KHz] |
|-------|------------|------------------|-------------------|
| VGA   | 640x480    | 60               | 31.5              |
|       | 640x480    | 72               | 37.9              |
|       | 640x480    | 75               | 37.5              |
|       | 640x480    | 85               | 43.3              |
|       | 640x480    | 120              | 61.9              |

|               |           |          |      |
|---------------|-----------|----------|------|
| SVGA          | 800x600   | 56       | 35.1 |
|               | 800x600   | 60       | 37.9 |
|               | 800x600   | 72       | 48.1 |
|               | 800x600   | 75       | 46.9 |
|               | 800x600   | 85       | 53.7 |
|               | 800x600   | 120      | 77.4 |
| XGA           | 1024x768  | 60       | 48.4 |
|               | 1024x768  | 70       | 56.5 |
|               | 1024x768  | 75       | 60.0 |
|               | 1024x768  | 85       | 68.7 |
|               | 1024x768  | 120      | 99.0 |
| SXGA          | 1152x864  | 70       | 63.8 |
|               | 1152x864  | 75       | 67.5 |
|               | 1152x864  | 85       | 77.1 |
|               | 1280x1024 | 60       | 64.0 |
|               | 1280x1024 | 72       | 77.0 |
|               | 1280x1024 | 75       | 80.0 |
|               | 1280x1024 | 85       | 91.1 |
| QuadVGA       | 1280x960  | 60       | 60.0 |
|               | 1280x960  | 75       | 75.2 |
| SXGA+         | 1400x1050 | 60       | 65.3 |
| UXGA          | 1600x1200 | 60       | 75.0 |
| PowerBook G4  | 640x480   | 60       | 31.4 |
| PowerBook G4  | 640x480   | 66.6(67) | 34.9 |
| PowerBook G4  | 800x600   | 60       | 37.9 |
| PowerBook G4  | 1024x768  | 60       | 48.4 |
| PowerBook G4  | 1152x870  | 75       | 68.7 |
| PowerBook G4  | 1280x960  | 75       | 75.0 |
| i Mac DV (G3) | 1024x768  | 75       | 60.0 |

## 2 HDMI - Extended Wide timing

| Modes | Resolution  | V.Frequency [Hz] | H.Frequency [KHz] |
|-------|-------------|------------------|-------------------|
| WXGA  | 1280x768    | 60               | 47.8              |
|       | 1280x768    | 75               | 60.3              |
|       | 1280x768    | 85               | 68.6              |
|       | 1280x720    | 60               | 44.8              |
|       | 1280x720    | 120              | 92.9              |
|       | 1280x800    | 60               | 49.6              |
|       | 1280x800-RB | 119.909          | 101.6             |
|       | 1440x900    | 60               | 59.9              |
|       | 1920x1200   | 60               | 74                |

|        |                      |       |       |
|--------|----------------------|-------|-------|
| WSXGA+ | 1680x1050            | 60    | 65.3  |
|        | 1920x1080<br>(1080P) | 60    | 67.5  |
|        | 1366x768             | 60    | 47.7  |
| WUXGA  | 1920x1200-RB         | 59.94 | 74.04 |

### 3 HDMI - Video Signal

| Modes | Resolution         | V.Frequency [Hz] | H.Frequency [KHz] |
|-------|--------------------|------------------|-------------------|
| 480i  | 720x480 (1440x480) | 59.94 (29.97)    | 15.7              |
| 576i  | 720x576 (1440x576) | 50 (25)          | 15.6              |
| 480p  | 720x480            | 59.94            | 31.5              |
| 576p  | 720x576            | 50               | 31.3              |
| 720p  | 1280x720           | 60               | 45.0              |
| 720p  | 1280x720           | 50               | 37.5              |
| 1080i | 1920x1080          | 60 (30)          | 33.8              |
| 1080i | 1920x1080          | 50 (25)          | 28.1              |
| 1080p | 1920x1080          | 23.97/24         | 27.0              |
| 1080p | 1920x1080          | 60               | 67.5              |
| 1080p | 1920x1080          | 50               | 56.3              |
| 1080p | 1920x1200-RB       | 59.94            | 74.04             |

### 4 HDMI - 1.4a 3D Timing

| Modes                                  | Resolution            | V.Frequency [Hz] | H.Frequency [KHz] |
|--|-----------------------|------------------|-------------------|
| 720p (Frame Packing)                   | 1280x720              | 50               | 37.5              |
| 720p (Frame Packing)                   | 1280x720              | 60               | 45.0              |
| 1080p (Frame Packing )                 | 1920x1080             | 24               | 27.0              |
| 720p (Frame Packing)                   | 1280x720              | 50               | 37.5              |
| 720p (Frame Packing)                   | 1280x720              | 60               | 45.0              |
| 1080i (Top and Bottom)                 | 1920x1080             | 50 (25)          | 28.1              |
| 1080i (Top and Bottom)                 | 1920x1080             | 60 (30)          | 33.8              |
| 1080p (Top and Bottom)                 | 1920x1080             | 24               | 27.0              |
| 1080p (Top and Bottom)                 | 1920x1080             | 50               | 56.3              |
| 1080p (Top and Bottom)                 | 1920x1080             | 60               | 67.5              |
| 720p (Side by Side (Half))             | 1280x720              | 60               | 45.0              |
| 1080i (Side by Side (Half))            | 1920x1080             | 50 (25)          | 28.1              |
| 1080i (Side by Side (Half))            | 1920x1080             | 60 (30)          | 33.8              |
| 1080p (Side by Side (Half))            | 1920x1080             | 50               | 56.3              |
| 1080p (Side by Side (Half))            | 1920x1080             | 60               | 67.5              |
| Graphic source monitor<br>range limits | Horizontal scan rate: |                  | 15k-100 kHz       |
|  | Vertical scan rate:   |                  | 24-120 Hz         |
|  | Max. pixel rate:      |                  | Analog:165 MHz    |

## C. MHL Digital

| Modes                                     | Resolution            | V.Frequency [Hz] | H.Frequency [KHz] |
|---|-----------------------|------------------|-------------------|
| VGA                                       | 640x480               | 59.94/60         | 31.5              |
| 480i                                      | 720x480 (1440x480)    | 59.94/60         | 15.7              |
| 576i                                      | 720x576 (1440x576)    | 50(25)           | 15.6              |
| 480p                                      | 720x480               | 59.94/60         | 31.5              |
| 480p_2x                                   | 1440x480              | 59.94/60         | 31.5              |
| 576p                                      | 720x576               | 50               | 31.3              |
| 576p_2x                                   | 1440x576              | 50               | 31.3              |
| 720p                                      | 1280x720              | 59.94/60         | 45.0              |
| 720p                                      | 1280x720              | 50               | 37.5              |
| 1080i                                     | 1920x1080             | 60(30)           | 33.8              |
| 1080i                                     | 1920x1080             | 50(25)           | 28.1              |
| 1080p                                     | 1920x1080             | 23.97/24         | 27.0              |
| 1080p                                     | 1920x1080             | 25               | 28.1              |
| 1080p                                     | 1920x1080             | 29.97/30         | 33.8              |
| Graphic source<br>monitor range<br>limits | Horizontal scan rate: | 15k-50 kHz       |                   |
|   | Vertical scan rate:   | 24-60 Hz         |                   |
|   | Max. pixel rate:      | Digital: 75 MHz  |                   |



.....  
**Note:** Functions vary depending on model definition.

# Regulations and safety notices

## FCC notice

This device has been tested and found to comply with the limits for a Class B digital device pursuant to Part 15 of the FCC rules. These limits are designed to provide reasonable protection against harmful interference in a residential installation. This device generates, uses, and can radiate radio frequency energy and, if not installed and used in accordance with the instructions, may cause harmful interference to radio communications.

However, there is no guarantee that interference will not occur in a particular installation. If this device does cause harmful interference to radio or television reception, which can be determined by turning the device off and on, the user is encouraged to try to correct the interference by one or more of the following measures:

- Reorient or relocate the receiving antenna.
- Increase the separation between the device and receiver.
- Connect the device into an outlet on a circuit different from that to which the receiver is connected.
- Consult the dealer or an experienced radio/television technician for help.

## Notice: Shielded cables

All connections to other computing devices must be made using shielded cables to maintain compliance with FCC regulations.

## Notice: Peripheral devices

Only peripherals (input/output devices, terminals, printers, etc.) certified to comply with the Class B limits may be attached to this equipment. Operation with non-certified peripherals is likely to result in interference to radio and TV reception.

## Caution

Changes or modifications not expressly approved by the manufacturer could void the user's authority, which is granted by the Federal Communications Commission, to operate this device.

## Operation conditions

This device complies with Part 15 of the FCC Rules. Operation is subject to the following two conditions: (1) this device may not cause harmful interference, and (2) this device must accept any interference received, including interference that may cause undesired operation.

## Notice: Canadian users

This Class B digital apparatus complies with Canadian ICES-003.



## Remarque à l'intention des utilisateurs canadiens

Cet appareil numérique de la classe B est conforme à la norme NMB-003 du Canada.

## Declaration of Conformity for EU countries

Acer hereby declares that this projector series is in compliance with the essential requirements and other relevant provisions of Directive 1999/5/EC.

Compliant with Russian regulatory certification



## Radio device regulatory notice



.....

**Note:** The regulatory information below is for models with wireless LAN and/or Bluetooth only.

## General

This product complies with the radio frequency and safety standards of any country or region in which it has been approved for wireless use. Depending on configurations, this product may or may not contain wireless radio devices (such as wireless LAN and/or Bluetooth modules).

## Canada — Low-power license-exempt radio communication devices (RSS-247)

- a Common information
  - Operation is subject to the following two conditions:
    1. This device may not cause interference, and
    2. This device must accept any interference, including interference that may cause undesired operation of the device.
- b Operation in 2.4 GHz band
  - To prevent radio interference to the licensed service, this device is intended to be operated indoors and installation outdoors is subject to licensing.

## List of applicable countries

This device must be used in strict accordance with the regulations and constraints in the country of use. For further information, please contact the local office in the country of use. Please see <http://ec.europa.eu/enterprise/rte/implem.htm> for the latest country list.



**Acer Incorporated**  
8F, 88, Sec. 1, Xintai 5th Rd., Xizhi  
New Taipei City 221, Taiwan

## Declaration of Conformity

We,

**Acer Incorporated**

8F, 88, Sec. 1, Xintai 5th Rd., Xizhi, New Taipei City 221, Taiwan

And,

**Acer Italy s.r.l.**

Via Lepetit, 40, 20020 Lainate (MI) Italy

Tel: +39-02-939-921 ,Fax: +39-02 9399-2913

www.acer.it

**Product:** DLP Projector  
**Trade Name:** Acer  
**Model Number:** DNX1520/DWX1519/D7P1602/D1P1518/D1P1601  
A1200/B110/CE-X10/C11X/AX331/  
A1300W/B120/CE-W10/C11W/AW331/  
H5382BD/E232/HE-722/  
A1500/B150/CE-810/H6511BD/  
H6512BD/E146D/HE-805J/L552/V62/H6510BD+/P1502

We, Acer Incorporated, hereby declare under our sole responsibility that the product described above is in conformity with the relevant Union harmonization legislations as below Directive and following harmonized standards and/or other relevant standards have been applied:

|   |  |   |
|---|--|---|
| <input checked="" type="checkbox"/> <b>EMC Directive: 2014/30/EU</b>                  |  |   |
| <input checked="" type="checkbox"/> EN 55032:2012+AC:2013, Class B                    | <input checked="" type="checkbox"/> EN 61000-3-2:2014, Class A       |   |
| <input checked="" type="checkbox"/> EN 55024:2010+A1:2015                             | <input checked="" type="checkbox"/> EN 61000-3-3:2013                |   |
| <input type="checkbox"/> <b>R&amp;TTE Directive: 1999/5/EC (until Jun 12, 2017)</b>   |  |   |
| <input type="checkbox"/> <b>RED Directive: 2014/53/EU (From Jun 13, 2017)</b>         |  |   |
| <input type="checkbox"/> EN 300 328 V1.9.1  | <input type="checkbox"/> EN 301 511 V9.0.2                           | <input type="checkbox"/> EN 301 489-7 V1.3.1  |
| <input type="checkbox"/> EN 301 893 V1.7.1  | <input type="checkbox"/> EN 301 908-1 V6.2.1                         | <input type="checkbox"/> EN 301 489-17 V2.2.1 |
| <input type="checkbox"/> EN 300 440-1 V1.6.1  | <input type="checkbox"/> EN 301 908-2 V6.2.1                         | <input type="checkbox"/> EN 301 489-24 V1.5.1 |
| <input type="checkbox"/> EN 300 440-2 V1.4.1  | <input type="checkbox"/> EN 301 908-13 V6.2.1                        | <input type="checkbox"/> EN 50360:2001        |
| <input type="checkbox"/> EN 302 291-1 V1.1.1  | <input type="checkbox"/> EN 301 489-1 V1.9.2                         | <input type="checkbox"/> EN 50566:2013        |
| <input type="checkbox"/> EN 302 291-2 V1.1.1  | <input type="checkbox"/> EN 301 489-3 V1.6.1                         | <input type="checkbox"/> EN 62479:2010        |
|   |  | <input type="checkbox"/> EN 62311:2008        |
|   |  | <input type="checkbox"/> EN 62209-1:2006      |
|   |  | <input type="checkbox"/> EN 62209-2:2010      |
| <input checked="" type="checkbox"/> <b>LVD Directive: 2014/35/EU</b>                  |  |   |
| <input checked="" type="checkbox"/> EN 60950-1:2006/A11:2009/A1:2010/A12:2011/A2:2013 |  |   |
| <input type="checkbox"/> EN 50332-1:2013  | <input type="checkbox"/> EN 50332-2:2013                             |   |
| <input checked="" type="checkbox"/> <b>RoHS Directive: 2011/65/EU</b>                 |  |   |
| <input checked="" type="checkbox"/> EN 50581:2012                                     |  |   |
| <input checked="" type="checkbox"/> <b>ErP Directive: 2009/125/EC</b>                 |  |   |
| <input type="checkbox"/> Regulation (EU) No. 617/2013                                 | <input type="checkbox"/> Regulation (EC) No. 278/2009; EN 50563:2011 |   |
| <input checked="" type="checkbox"/> Regulation (EC) No. 1275/2008; EN 50564:2011      |  |   |

Year to begin affixing CE marking 2017.

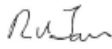
  
\_\_\_\_\_  
RU Jan / Sr. Manager  
Acer Incorporated (Taipei, Taiwan)

\_\_\_\_\_  
Jan. 1, 2017  
Date



Acer America Corporation  
333 West San Carlos St.,  
Suite 1500  
San Jose, CA 95110  
U. S. A.  
Tel: 254-298-4000  
Fax: 254-298-4147  
www.acer.com



## Federal Communications Commission Declaration of Conformity

This device complies with Part 15 of the FCC Rules. Operation is subject to the following two conditions: (1) this device may not cause harmful interference, and (2) this device must accept any interference received, including interference that may cause undesired operation.

The following local Manufacturer / Importer is responsible for this declaration:

|                                      |  |
|--------------------------------------|--|
| <b>Product:</b>                      | DLP Projector  |
| <b>Model Number:</b>                 | DNX1520/DWX1519/D7P1602/D1P1518/D1P1601  |
| <b>Machine Type:</b>                 | A1200/B110/CE-X10/C11X/AX331/<br>A1300W/B120/CE-W10/C11W/AW331/<br>H5382BD/E232/HE-722/<br>A1500/B150/CE-810/H6511BD/<br>H6512BD/E146D/HE-805J/L552/N62/<br>H6510BD+/P1502 |
| <b>Address of Responsible Party:</b> | 333 West San Carlos St.<br>Suite 1500<br>San Jose, CA 95110<br>U. S. A.  |
| <b>Contact Person:</b>               | Acer Representative  |
| <b>Phone No.:</b>                    | 254-298-4000   |
| <b>Fax No.:</b>                      | 254-298-4147   |